Patching & Splicing Shelf

Contents

1 Introduction	5 Fiber routing
2 General	5.1 Installation of loose tube on the tray
2.1 Kit contents	5.2 Installation of IFC on the tray
2.2 Tools	5.3 Installation of break out cable/pigtail on the tray
2.3 Optional accessories	5.4 Installation of ribbon on the tray
3 Installation of the shelf	5.5 Installation of ribbon pigtail on the tray
3.1 Mounting of shelf in the rack	6 Storage
3.2 Preparation of the shelf	7 Patching
3.3 Preparation of the trays	8 Closing the shelf
4 Cable termination	9 Important steps
4.1 Cable termination in the rack	
A Loose tube cable	
B Loose tube ribbon cable	
C Central core cable	
D IFC cable	
E Modular cable	
4.2 Side cable termination directly on the shelf using cable termination plate	
A Loose tube cable	
B IFC cable/break-out cable	
4.3 Back cable termination directly on the shelf using cable termination plate	
A Loose tube cable	
B IFC cable	

1 Introduction

Product function

This shelf is a mechanical enclosure for a physical fiber management system.

It is used for splicing and patching: splicing primary coated fiber from loose tube cable or pigtails to fiber pigtails on a single element base and connector patching to patchcords with a capacity of 144 (= 6 x 24) splices and connections.

It is a high density multifunctional unit designed for particular applications and environments.

This unit uses Patching/Splicing Trays with 12 connector positions.

The GPST-12 trays house the splices, slack fiber, connectors, pigtails and patchcords.

It can be installed in Tyco's FIST rack and other 19" or metric (ETSI) racks.

Follow local safety regulations related to optical fiber plant elements.

2 General

2.1 Kit contents



2.1.1 Patch cord IN - patch cord OUT (example: FIST-GPS2-M-AAA-6)

1 unit, incorporating

- Metal chassis with drawer,
- Hingable and removable metal front cover
- Hinge and Velcro strap for installation of GPST-12 trays
- 2 pigtail horns
- 2 tray support wedges
- 6 GPST-12 Trays (If preinstalled)
- Cage-nuts and bolts
- Mounting brackets + screws
- Installation instructions
- ID labels

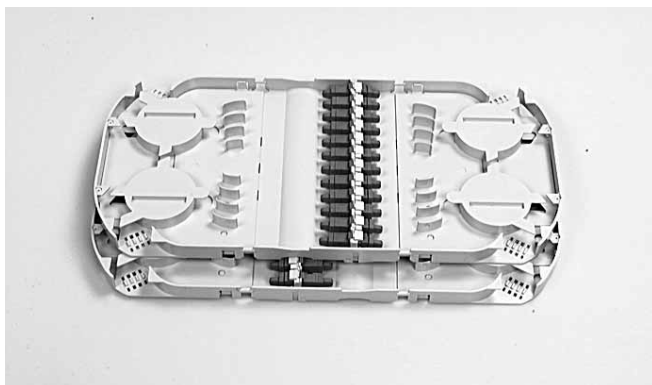

2.1.2 GPST-12 tray configuration: (Patch only) (example: FIST-GPST-12-AAA-2)

- Tray with 2x patch Unit
- 12 connector adapters per tray
- Always delivered in sets of 2 complementary pieces



2.1.3 Loose Tube/preconnectorized IFC IN- patchcord OUT (example: FIST-GPS2-M-AIA-6)

1 unit, incorporating

- Metal chassis with drawer,
- Hingable and removable metal front cover
- Hinge and Velcro strap for installation of GPST-12 trays
- 2 pigtail horns
- 2 tray support wedges
- 6 GPST-12 Trays (If preinstalled), prefibered
- Cage-nuts and bolts
- Mounting brackets + screws
- Tie wraps + adhesive foam
- Installation instructions
- ID labels

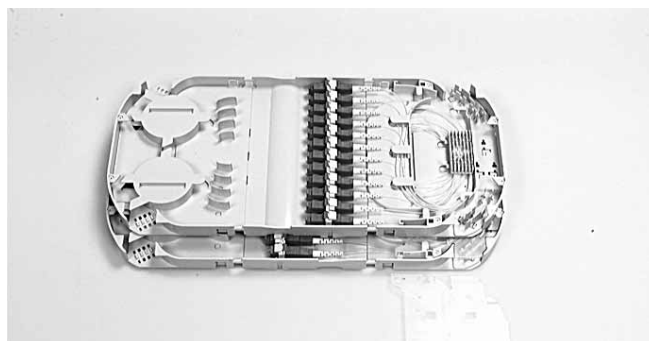

2.1.4 GPST-12 tray configuration: Patch/splice (Loose Tube and preconnectorised IFC cable) (example: FIST-GPST-12-AIA-2)

- Tray with 1x patch and 1x Splice Unit with splice holder for 12 SMOUV-02 (45 mm)
- 12 Connector adapters and pigtails per tray (no pigtails in case of IFC)
- 12 SMOUV (splice protector) per tray
- Always delivered in sets of 2 complementary pieces



2.1.5 Non-preconnectorized break-out cable IN-patchcord OUT (example: FIST-GPS2-M-AKA-6)

1 unit, incorporating

- metal chassis with drawer,
- Hingable and removable metal front cover
- Hinge and Velcro strap for installation of GPST-12 trays
- 2 pigtail horns
- 2 tray support wedges
- 6GPST-12 Trays (if preinstalled)
- Cage-nuts and bolts
- 18 GTU(Group Termination Unit)
- Mounting brackets + screws
- Installation instructions
- ID labels

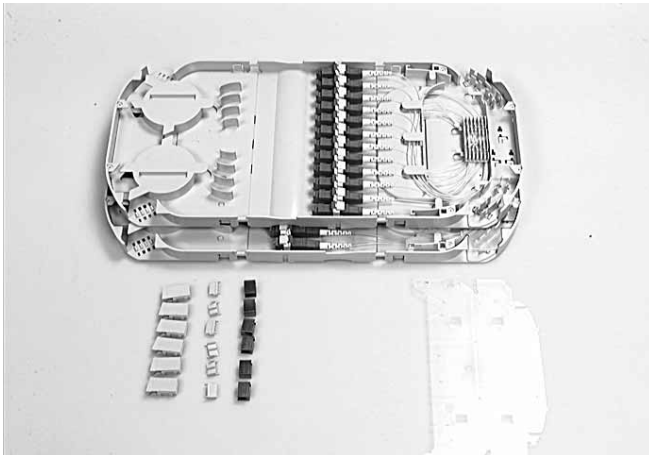

2.1.6 GPST-12 tray configuration:(Patch/splice) (Breakout cable) (Example: FIST-GPST-12-AKA-2)

- Tray with 1x patch and 1x Splice Unit with splice holder for 12 SMOUV-02 (45 mm)
- 12 connector adapters and pigtails per tray
- 3 GTU's (Group Termination Unit) per tray
- 12 SMOUV (splice protector) per tray
- Always delivered in sets of 2 complementary pieces

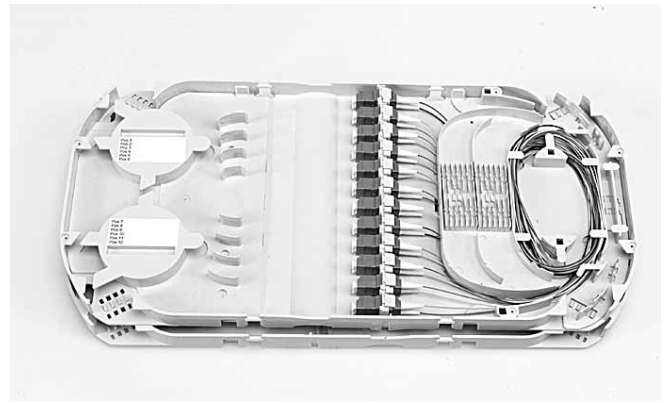

2.1.7 GPST-12 tray configuration : Patch / splice FIST-GPST-12-AML1-2

- Tray with 1x patch and 1x Splice Unit with splice holder for 24 SMOUV-02 (45 mm)
- 24 connector adapters and pigtails per tray
- 24 SMOUV (splice protector) per tray
- Always delivered in sets of 2 complementary pieces

2.2 Tools

- FACC-ALLEN-KEY-5-350 To mount the shelf in the rack
- FACC-CAGE-NUT-TOOL For easy installation of cage nuts in the rack
- FACC-TUBE-STRIPPER-02 Loose tube stripper
- FISTV-E7170-0003-S5027 Marker pen

2.3 Optional accessories*

- | | |
|---------------------|---|
| FIST-UST-3HU-B-A | Termination unit for 2 loose tube cables (top or bottom) |
| FIST-UST-3HU-B-B | Termination unit for 2 IF or BO cables (top or bottom) |
| FIST-UST-EXKIT-2CA | Upgrade for 2 extra cables on the standard termination unit |
| FIST-UST-XX | Side cable termination unit (max. 2 cables) |
| FIST-CT-B-2 | Back cable termination unit (max. 2 cables) |
| FIST-MB2-M | Adaptation bracket 19" ETSI (2 pcs) |
| FIST-MB2-M-AS | Asymmetric adaptation bracket 19" ETSI (2 pcs) |
| FISTV-E7187-6316 | Velcro rolls for pigtail |
| SMOUV-1120-02 | 45 mm SMOUV fusion splice protections |
| FIST-TUBE-5MM-30 | 5 mm tubing |
| FIST-GS-FLEX-12-50 | Flexible tubing, internal Ø 12 mm, 50 m |
| FIST-GS-FLEX-17-50 | Flexible tubing, internal Ø 17 mm, 50 m |
| FIST-GR-TD-5MM | Tube divider 6 IN/OUT (for GR) |
| FIST-GPS2-TD-5MM | Tube divider 6 IN/OUT (use in GPS2) |
| OC-ADK-... | Various connector mating adapter kits |
| OCP-... and OCJ-... | Various optical jumpers and pigtails |

* see appropriate ordering guide

Remark: 19" shelves have no bend controls on the platform, at the back of the drawer.

3 Installation of the shelf

3.1 Mounting of shelf in the rack

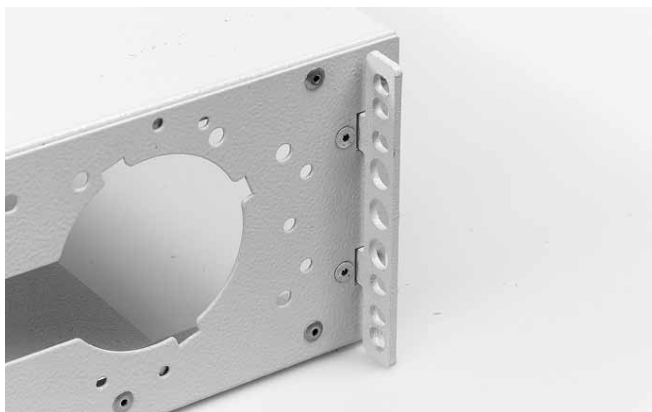

3.1.1 Install the mounting brackets on the correct position. Respect correct orientation. GR mounting is shown.

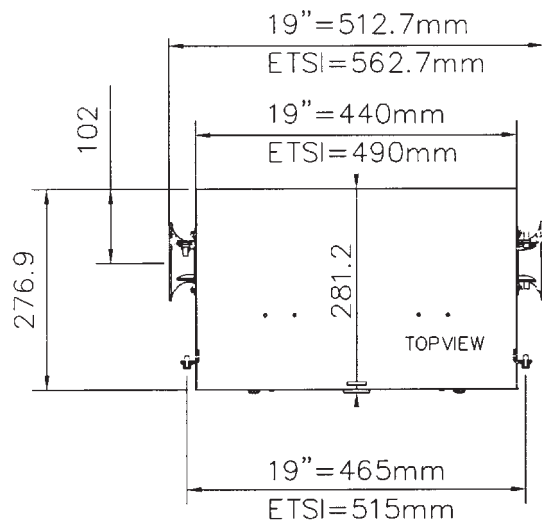
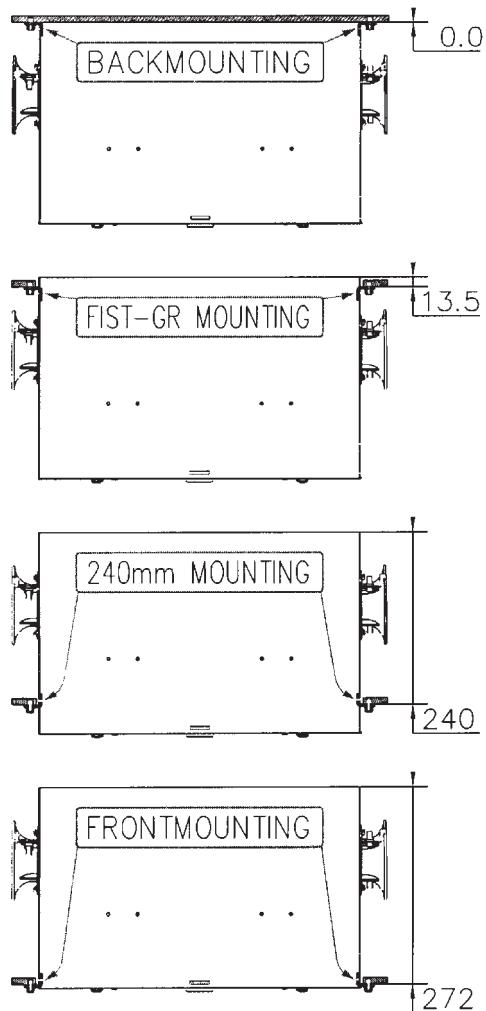

3.1.2 Different mounting positions

3.1.3 Space requirements

- 1 minimum 60 mm at left/right for horn and IFC or pigtails.
- 2 minimum 60 mm at left /right in case of cable side termination.
- 3 minimum 45 mm at back in case of cable back termination.

Spacing between adjacent units may vary depending on frame upright pitch and cable management products!



3.1.4 Determine the position of the shelf (see rack installation instruction). Fix the cage nuts into the rack mounting uprights (use the FACC-CAGE-NUT-Tool).



3.1.5 Mount the shelf using the FACC-ALLEN-Key.



3.1.6 In case of mounting 19" shelves in ETSI rack: mount the adaptation brackets (FIST-MB2-M).

3.2 Preparation of the shelf



3.2.1 If needed remove the cover by bending it carefully.



3.2.2 Pull the drawer to the fully open position and rotate the security-lip 180° to prevent the drawer from moving back inside the unit.



3.2.3 A horn is needed at the side where the pigtails are entering the shelf. Install the horn by positioning it centrally in the opening at the side of the shelf. Align the small knobs with the slots in the side, strongly push and turn until the locking pin click into positioning hole.

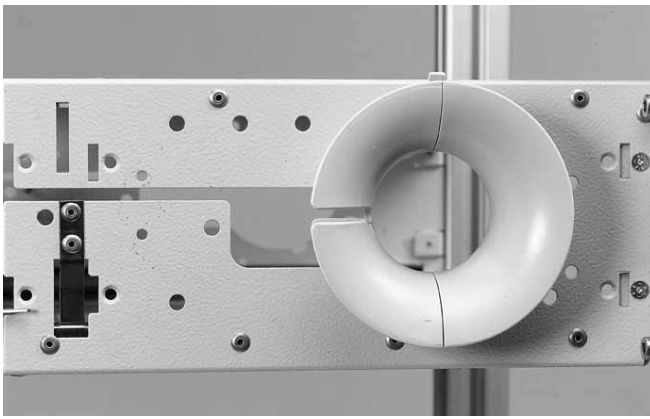

3.2.4 If needed the horn can easily be turned to an open position.

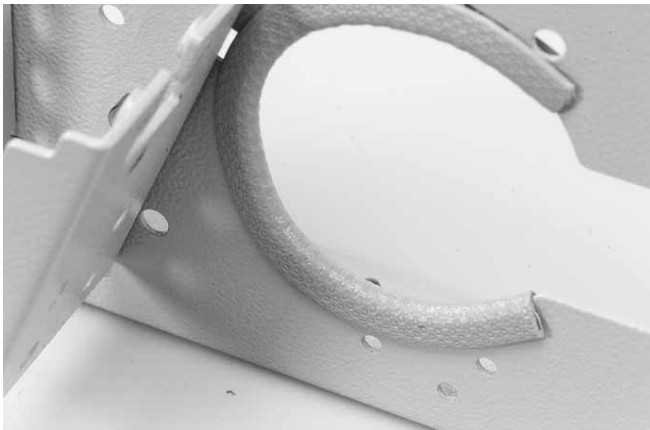

3.2.5 If is possible to install the edge protection.

3.3 Preparation of the trays

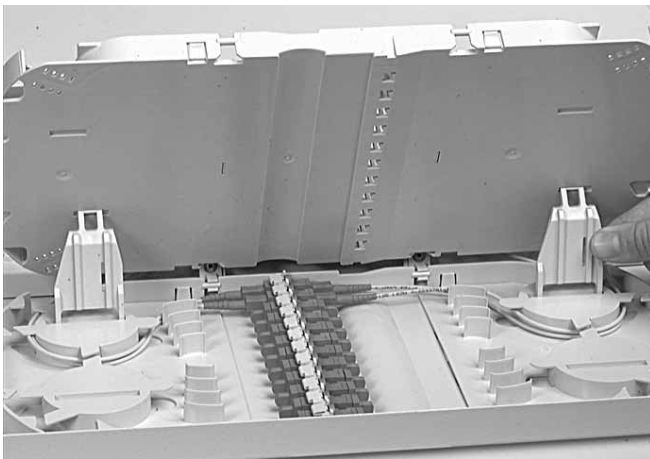

3.3.1 To make a tray accessible raise all the trays above. Keep these in position by using two tray wedges. The bottom tray is standard always marked with "L" at the front.

OUT

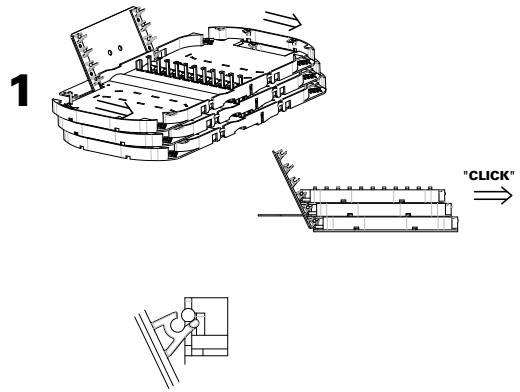

2

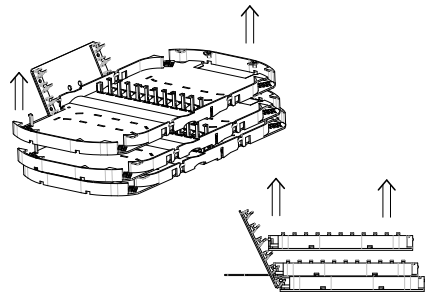

IN

1

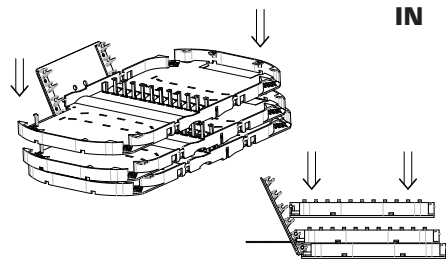

2

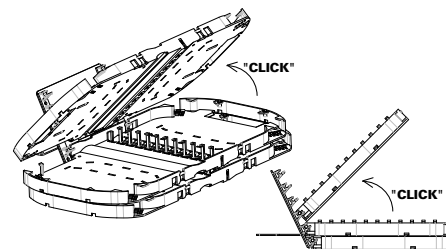

OR



3.3.2 All trays can easily be inserted or removed.

4 Cable termination

4.1 Cable termination in the rack

Cable is already terminated in the rack or in the side duct of the rack on the cable termination plate. For the loose tube cable the tubes are protected from the cable termination plate with the flex tube. For central core cable, fibers are guided into guiding tubes who go direct into the shelf.

A Loose tube cable (single fiber)

4.1.1 Cut a flex tube to length according the cable position in the rack and remove the cable jacket according this length. Make sure you have 2 m of loose tube inside the shelf.

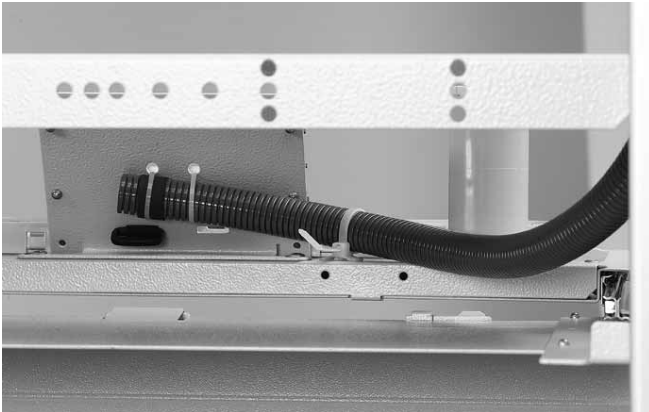

4.1.2 Make sure the flex tube is long enough so that the drawer slides easily in and out. Apply 1 layer of foam tape around the flex tube at 10 mm from the end. Secure the flex with two small tie-wraps at the hinge plate and a third tie-wrap at the platform.

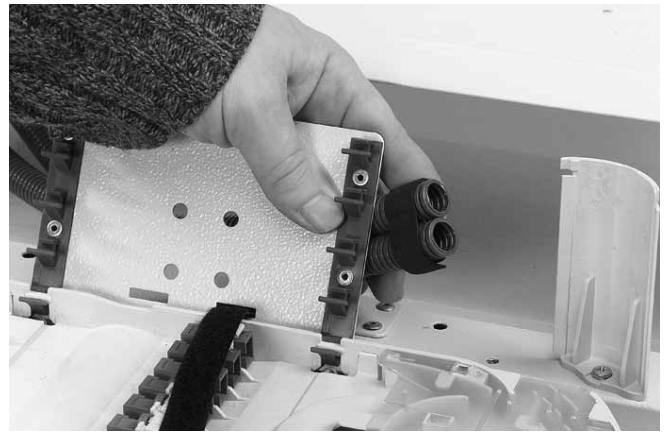

4.1.3 If necessary 2 flex tubes with a smaller diameter can be used. Apply 1 layer of foam tape around the flex tubes at 10 mm from the end. Use FIST-GS-FLEX-12-50.



4.1.4 Bundle the 2 tubes with the adhesive foam and mount them both at the initial installation. Secure the flex with two small tie-wraps at the hinge plate and with a third tie-wrap at the platform (1).

B Loose tube ribbon cable

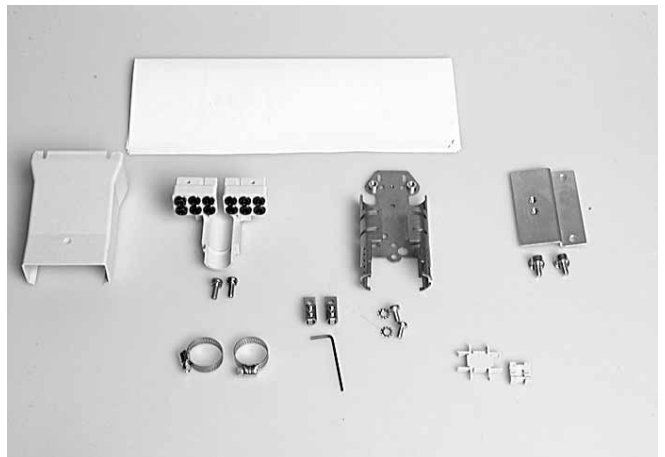

4.1.5 Kit content FIST-GR-CTB 100 (loose tube ribbon)

- Breakout device + screws
- Breakout device cover + screws
- Cable bracket + screws
- Mounting bracket + washers + screws
- 2 cable clamps
- Unraveling tool
- 2 strength member terminations + screws

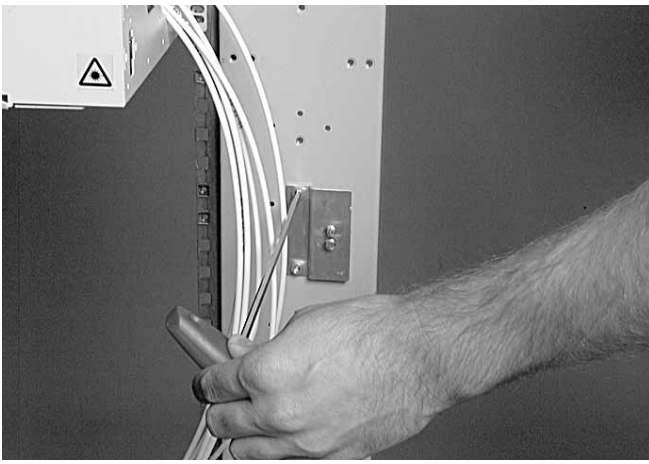

4.1.6 Choose a position in the side duct or on the cable termination plate, close to the shelf. Mount the mounting bracket on that position with the 2 screws.

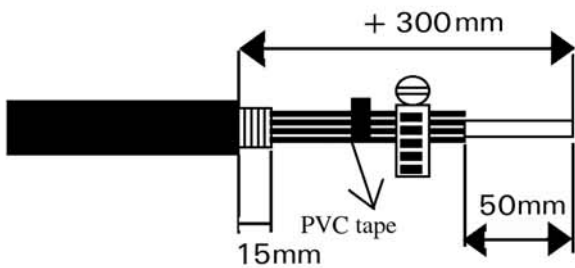

4.1.7 Loose tube ribbon cable.

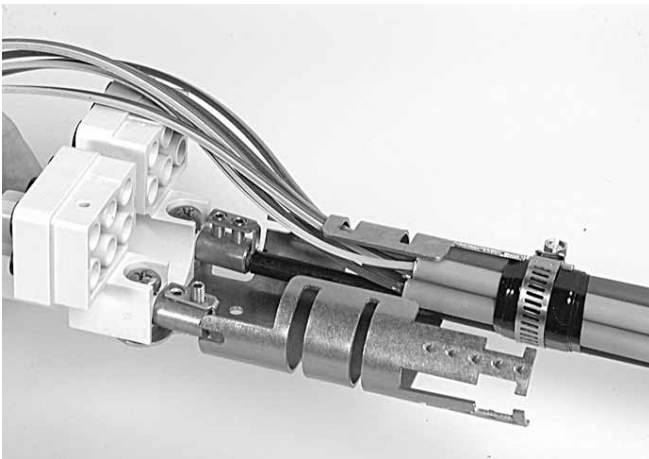

4.1.8 In case of loose tube cable: position the strength member at the bottom. Bundle the loose tubes with tape. Secure the strength member with the screws. Continue with installation from paragraph 4.1.15.

C Central core cable

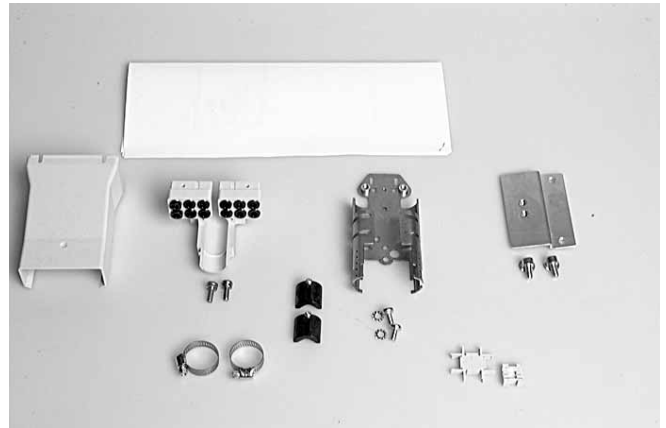

4.1.9 Kit content FIST-GR-CTB100CC (central core ribbon)

- Breakout device + screws
- Breakout cover device + screws
- Cable bracket + screws
- Mounting bracket + screws
- 2 cable clamps
- Unraveling tool
- 2 strength member stops + screws



4.1.10 Choose a position in the side duct or on the cable termination plate, close to the shelf. Mount the mounting bracket on that position with the 2 screws.

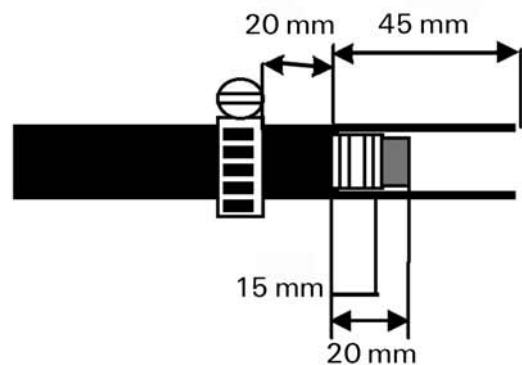

4.1.11 Central core ribbon cable.

Prepare the cable. Make sure you have 1,5 m of ribbon fiber on the tray. Respect dimensions shown on the drawings. Clean the fibers very well to make easy feeding possible.

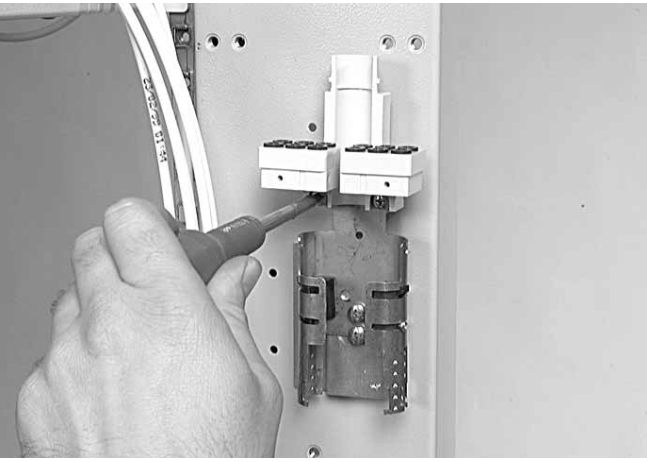

4.1.12 Mount the cable bracket with 2 screws on the mounting bracket and place the breakout device on the cable bracket.

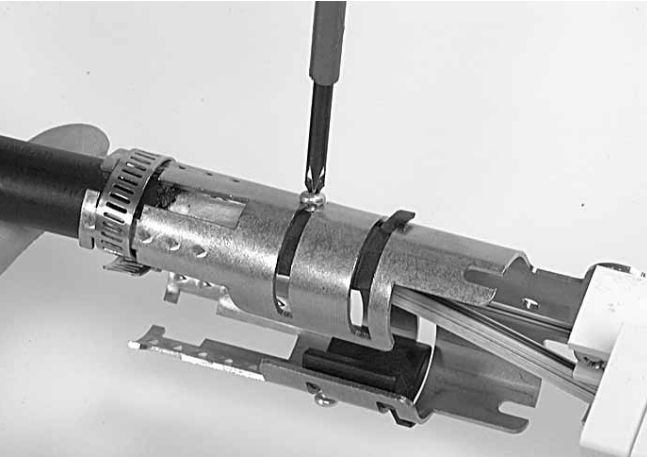

4.1.13 Loosen the screw of the strength member stop. Rotate the stop and position the strength members inside.



4.1.14 Secure with the cable clamp. Don't squeeze the cable.

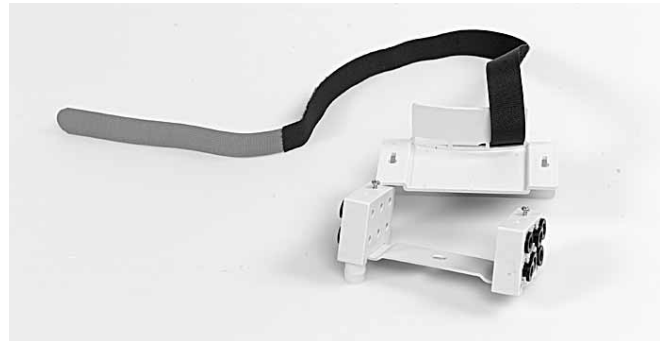

4.1.15 If extra split-out is needed the tube divider FIST-GPS2-TD-5MM can be mounted in the shelf. Assemble the tube divider as shown. Remove the Velcro strip from the shelf and mount it on the cover.

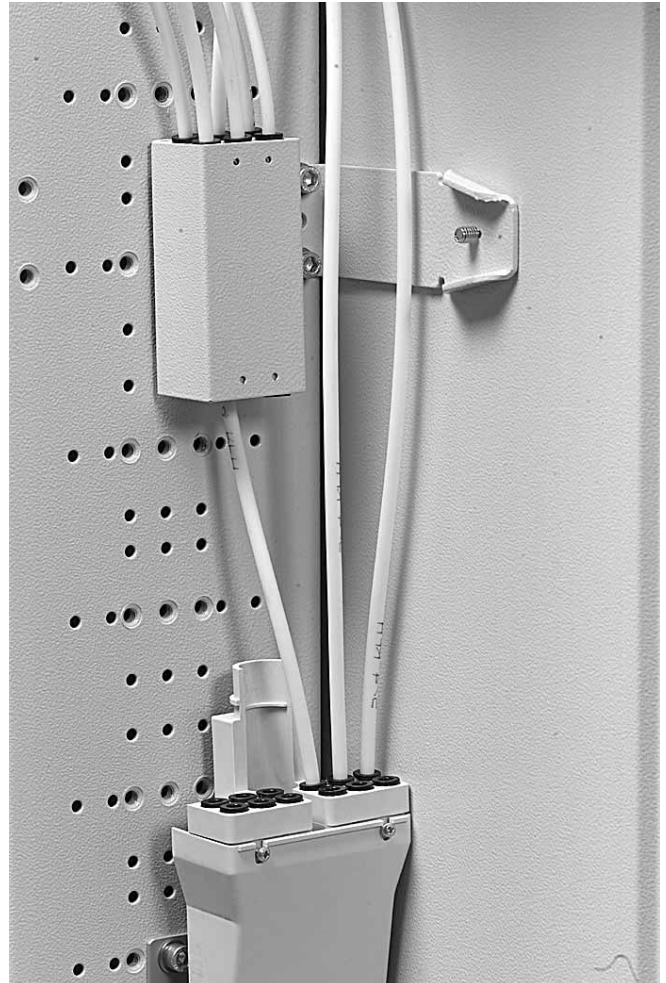

4.1.16 The tube divider FIST-GR-TD-5mm can be mounted in the rack. Install as shown. IN: maximum 6 tubes. OUT: maximum 6 tubes

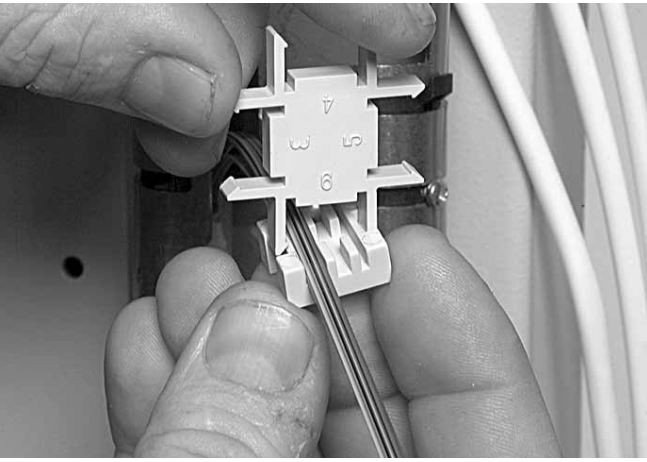

4.1.17 Remove twists in the ribbons.

- a) If ribbons are according ITU norms: use the unraveling device. The numbers indicate the number of ribbons you want to bundle (3-4-5 or 6). 3 sizes of ribbon can be handled: ribbon 12, 8 and 4 (3 groove sizes).
- b) In other cases use local practice.

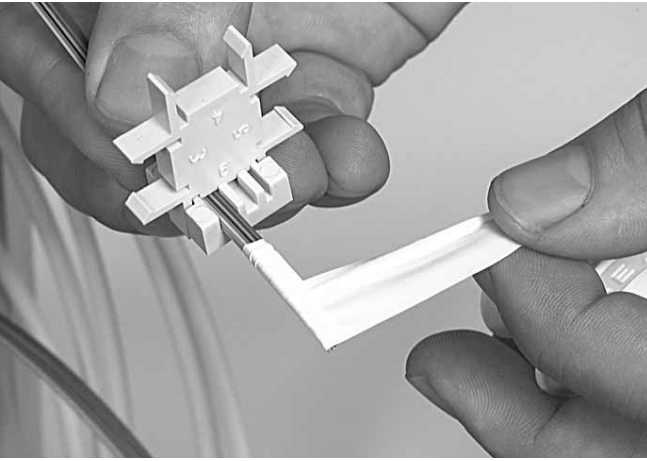

4.1.18 Slide the tool over the ribbons. Bundle at the end using Teflon tape (bundle in groups as you want to feed them through the tubes). Remove the unraveling device.

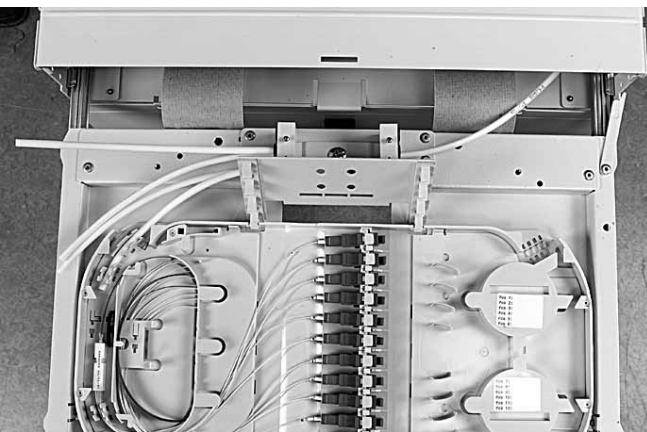

4.1.19 Mount the tube divider (if needed) on the metal tray. Cut the tubes coming from the break-out device to length. Remove the tube divider to have better access to split out the ribbons.

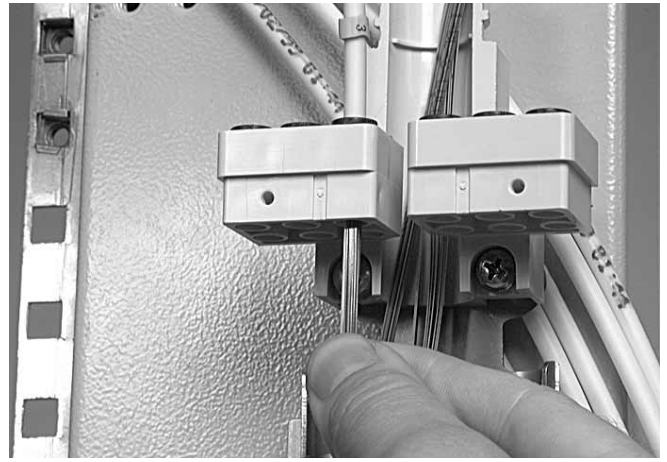

4.1.20 Insert the tubes in the connectors. Use 6 positions at the left when cable is mounted at the left side of the bracket. Feed the fiber groups in the tubes. Start at the back to have easy access. Avoid crossings of the fibers.



4.1.21 Slide the cover over the break-out and secure with the screws.

D IFC cable

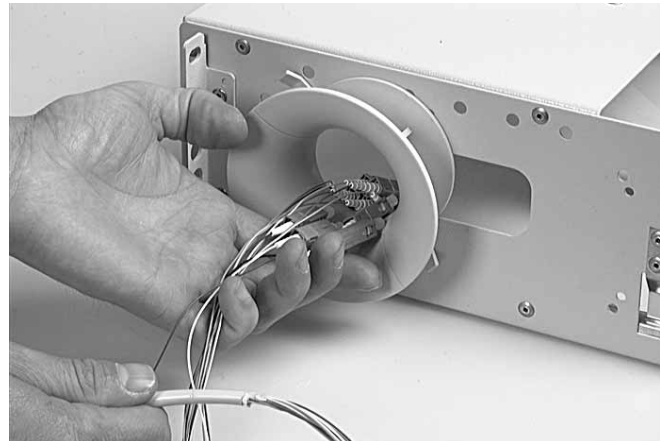

4.1.22 Feed the IFC sub-units through the horn and guide each IFC sub-unit to the rear entrance of the tray.

E Modular cable

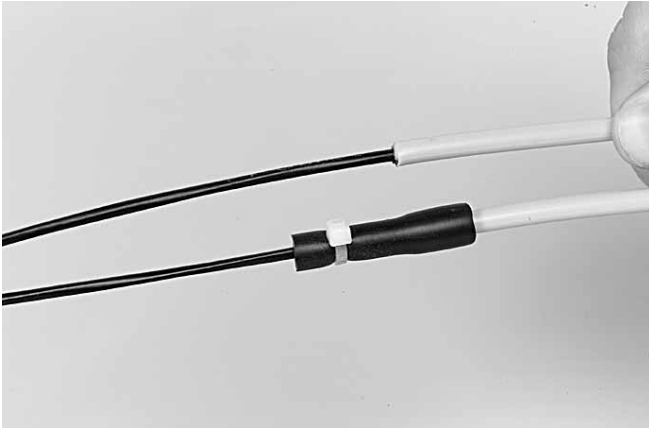

4.1.23 Slide a 30 mm long rubber tube over the transition and secure it with a tie-wrap on the inner tube as shown in the picture. The black tube goes directly through the trumpet onto the tray. Secure on the trays as described in 5.1.

4.2 Side cable termination directly on the shelf

A Loose tube cable

4.2.1 The cable can be terminated on the shelf: cable terminations are suited for max. 2 cables, cable retention with tie-wraps, the loose tubes are fed through a flexible tube to the shelf, the strength member is attached to the plate.

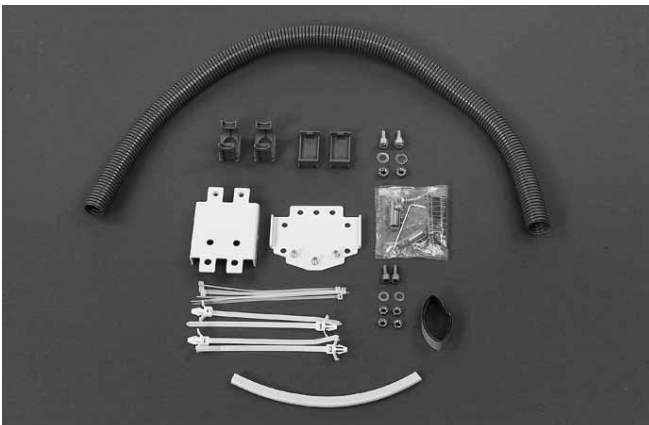

4.2.2 Kit content

- Metal plates
- Strength member connectors + screws
- Flexible tube (predefined length)
- Bolts and nuts
- Releasable tie-wraps
- Tube clips + lid
- Edge protection
- Foam strip
- Tie-wraps

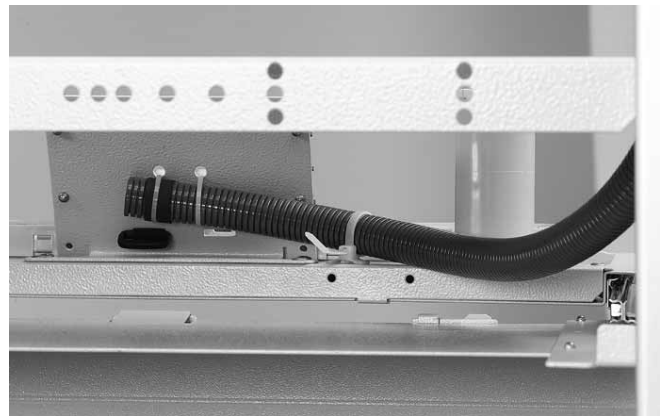

4.2.3 Fasten the flex tube (before trays are inserted) at the back of the metal hinge plate using 2 small tie-wraps and fix the flex tube with a third tie-wrap to the platform. Assume that tie-wraps are well tensioned to avoid slippage of the tube and cut the excess length of the tie-wraps. Knobs of the tie-wraps must be positioned at the FRONT of the metal hinge plate.



4.2.4 Remove the bend control at the side of the flex tube (only in ETSI shelf).

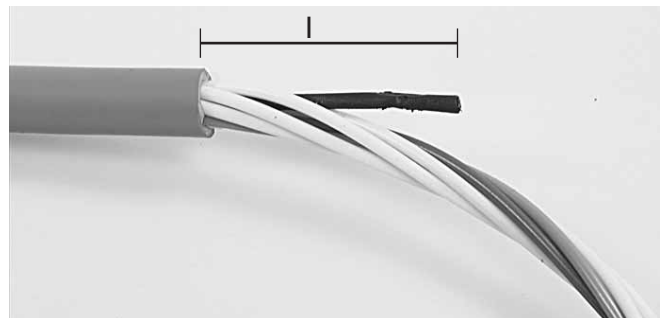

4.2.5 Remove the cable jacket over approximately 2.2 m. Wait to strip the loose tube to avoid fiber breakage. Cut the strength member to length ($l = 35$ mm).

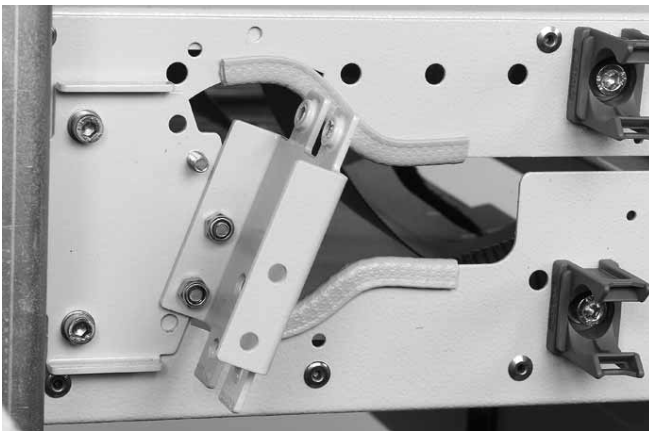

4.2.6 The picture shows left side mounting and cable coming from the bottom. Install both tube holders onto the shelf.

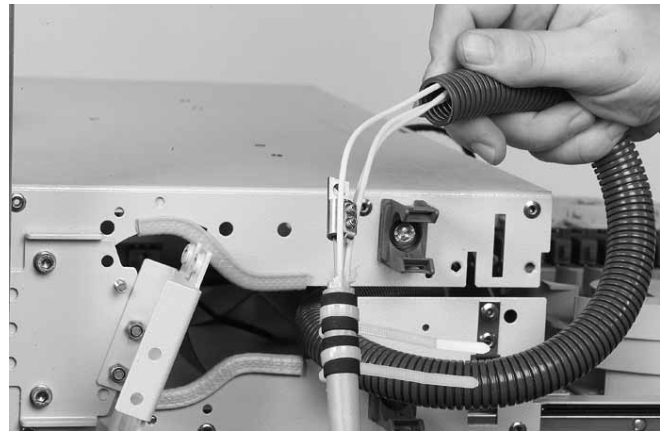

4.2.9 Guide the identified loose tubes into the flex tube. This can be facilitated by keeping the end of the loose tubes bundled together with a piece of tape.

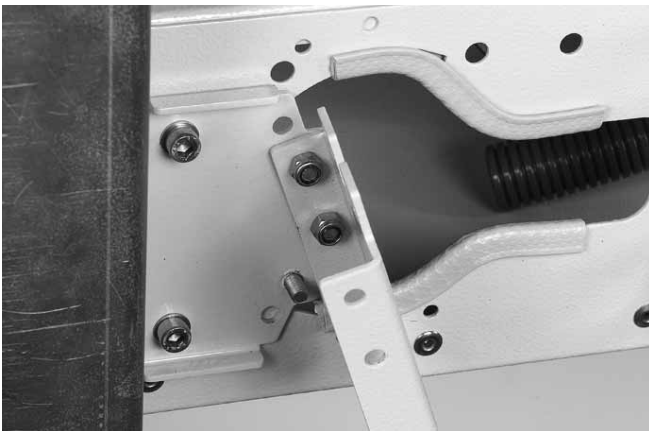

4.2.7 The picture shows left side mounting and cable coming from the top.



4.2.10 Fasten the flex tube at the bottom tube holder and afterwards at the top. Attach the push tie wraps onto the plate and fasten the strength member connector. Mount the cover on the flex tube holders.

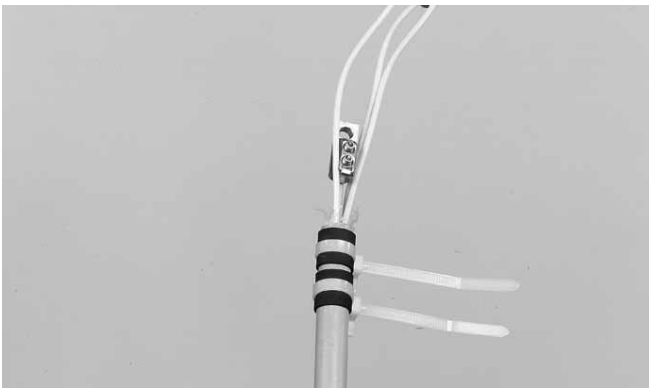

4.2.8 Place the foam and push the tie-wraps onto the cable as shown and install the strength member connector.

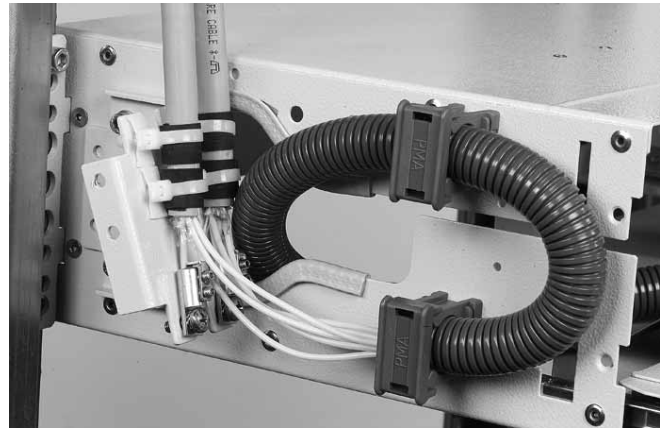

4.2.11 For cable coming from top use a reverse assembly.

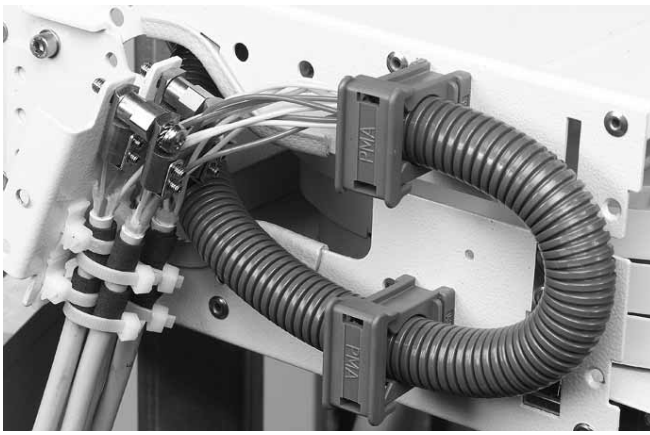

4.2.12 In case of max. 4 cables.
Use the FIST-UST-EXKIT-2CA for the extra 2 cables.

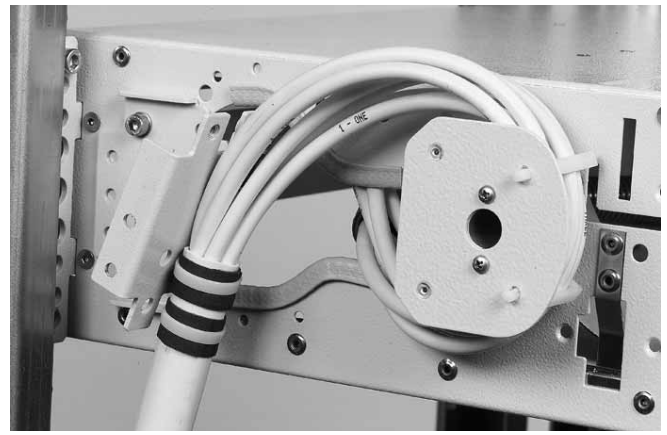

4.2.15 Cut the strength member to 35 mm maximum. Attach the strength member fixation and install as shown. Edge protection can be installed. Same routing and installation for break-out cable. Recommended to use GTU (see section 5.3).

B IFC cable/break-out cable



4.2.13 Kit content

- Metal plates
- Strength member connectors + screws
- Drum
- Bolts and nuts
- Releasable tie-wraps
- Clips
- Edge protection
- Foam strip
- Tie-wraps

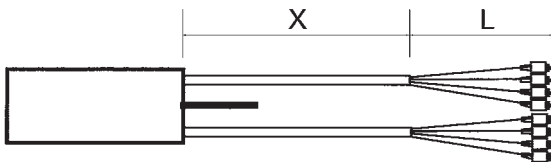

4.2.14 In case of IFC: remove $X = 0.8$ m of outer jacket. The recommended length of secondary fiber $L = 1.25-1.50$ m. In case of break out cable (not connectorized): remove $X + L = \text{max. } 2.3$ m of outer jacket.

4.3 Back cable termination directly on the shelf

4.3.1 Cable terminations are suited for 2 cables, max. 3, cable retention with tie-wraps. Loose tubes are fed through a flexible tube to the shelf, the strength member is attached to the plate. In case of IFC no flex tube is used.



4.3.2 Kit content

- Releasable tie-wraps
- Strength member connectors + screws
- Flexible tube (predefined length)
- Tube clip + lid
- Bolts and nuts
- Foam strip
- Metal plate
- Tie-wraps

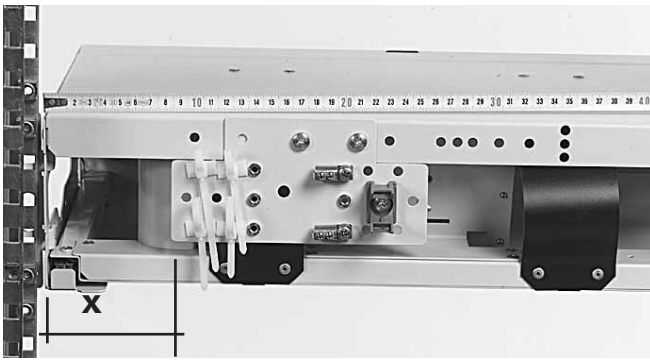

4.3.3 Assemble the components onto the termination plate. The picture shows cable coming from the left (seen from the back), for cable coming from the right the reverse assembly is required.
 X = 80 mm (19" shelf) or 105 mm (ETSI shelf)



4.3.6 Remove the bend control at the side of the flex tube (only in ETSI shelf).



4.3.4 Apply one layer of foam tape around the flex tube at approximately 10 mm from the end. This foam tape must be positioned underneath one of the tie-wraps (this tape prevents easy pull out of the flex tube).

A Loose tube cable

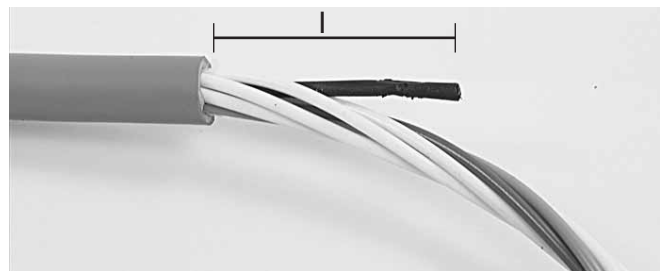

4.3.7 Remove the cable jacket over approximately 2 m. Wait to strip the loose tube to avoid fiber breakage. Cut the strength member to length (L = max. 60 mm) and fasten the strength member connector with the Allen key.

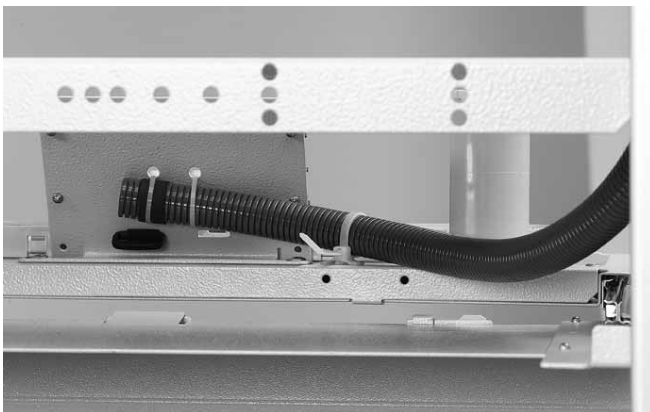

4.3.5 Fasten the flex tube (before trays are inserted) at the back of the metal hinge plate using 2 small tie-wraps and fix the flex tube with a third tie-wrap to the platform. Assure that tie-wraps are well tensioned to avoid slippage of the tube and cut the excess length of the tie-wraps. Knobs of the tie-wraps must be positioned at the FRONT of the metal hinge plate.

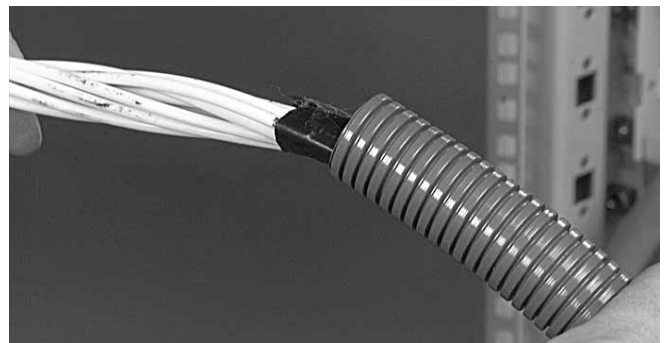

4.3.8 Guide the identified loose tubes into the flex tube. This can be facilitated by keeping the end of the loose tube bundled together with a piece of tape. Make a loop with the flexible tube behind the shelf and fix the flex tube into the clip of the termination plate.

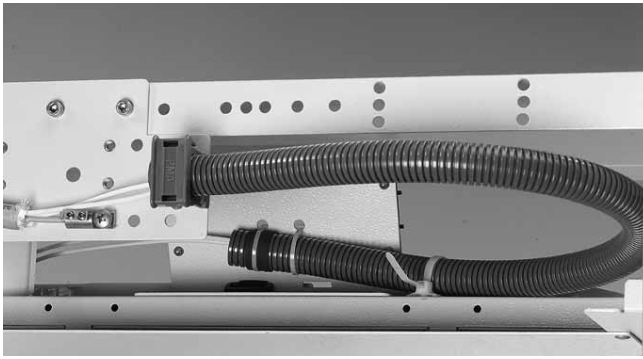

4.3.9 Attach the strength member connector to the back termination plate using a Philips screwdriver. Avoid unnecessary crossing of strength member and loose buffer tubes. Attach the cable with the releasable tie wraps on the outer jacket. Mount the cover on the flex tube holder.

B IFC

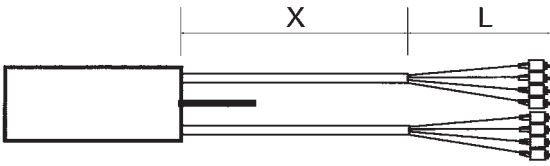

4.3.10 In case of IFC: remove $X = 0.7$ m of outer jacket. The recommended length of secondary fiber $L = 1,25-1,50$ m.

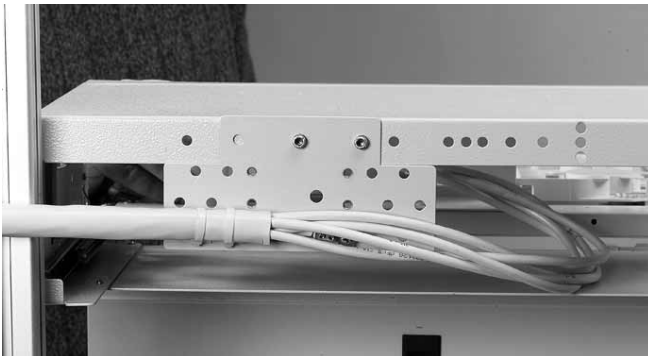

4.3.11 Cut the strength member at 60 mm maximum. Attach the strength member fixation and install as shown.

5 Fiber routing

5.1 Installation of loose tube on the tray
(Same procedure for modular cable)

12 splice module

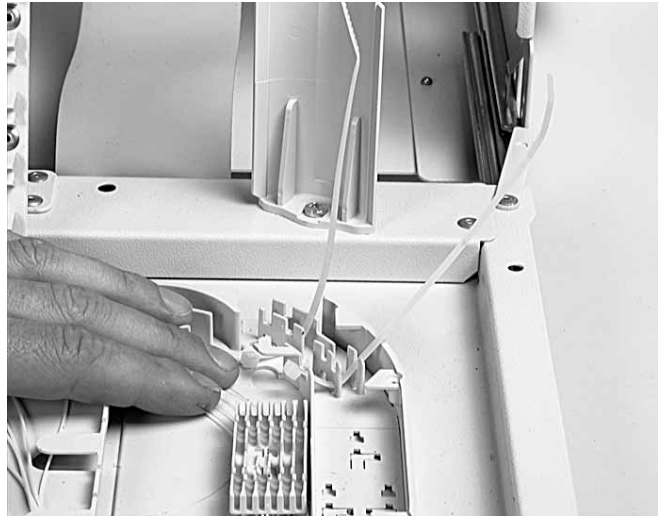

5.1.1 Identify the loose tubes and put the tie wraps in position on the tray as shown.

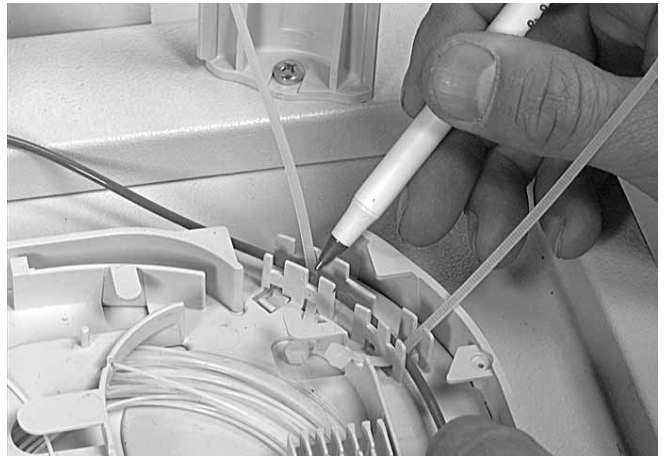

5.1.2 Bring the loose tubes on the tray and mark them at the first tie-wrap.



5.1.3 Cut a rubber foam to length and tape it around the loose tube.

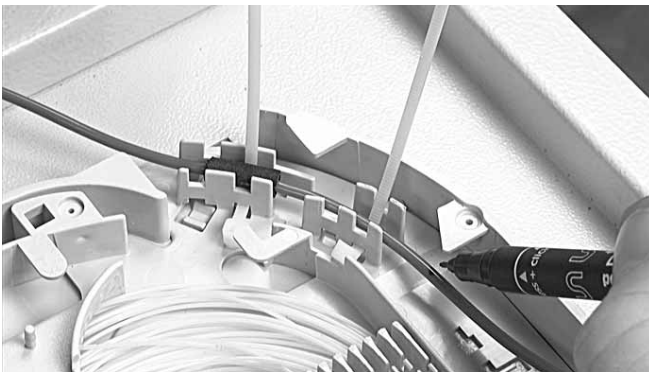

5.1.4 Push the loose tubes in the tray and mark them again 15 mm beyond the second tie wrap.

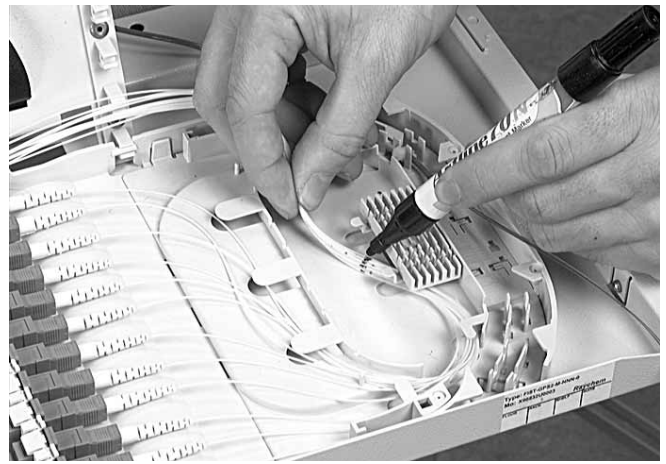

5.1.7 If applicable remove all the pre-mounted pigtails out of the storage area and mark the fibers at the splice holder. Remove the secondary coating from this point. This assures the transition primary-secondary is in a straight line! Not applicable with tight coated (900µm - storage max. 1.2 m), only semi-tight can be stripped.

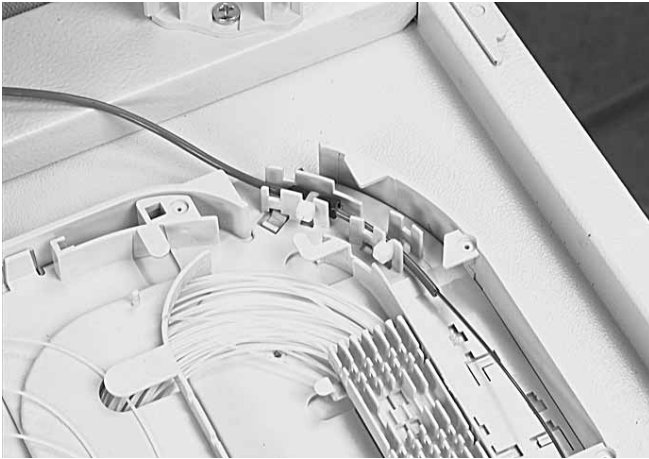

5.1.5 Strip the loose tubes at this second mark, clean the fibers and tighten the tie-wraps. Make sure the tie wrap knob is at the side of the tube.

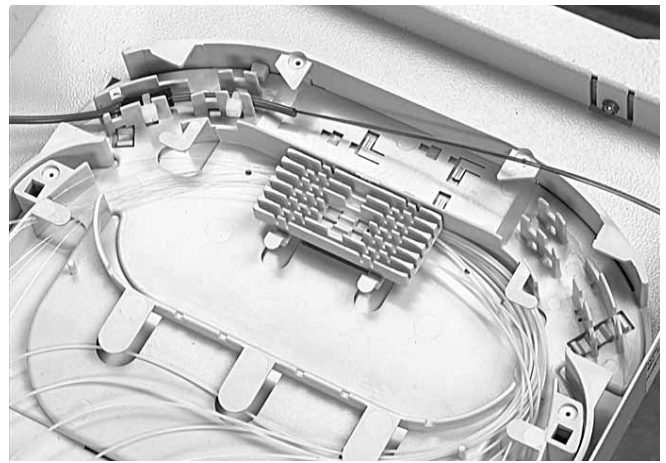

5.1.8 Position all the pigtails under the splice protection and leave them there. The fibers have to be kept in this position during further installation.

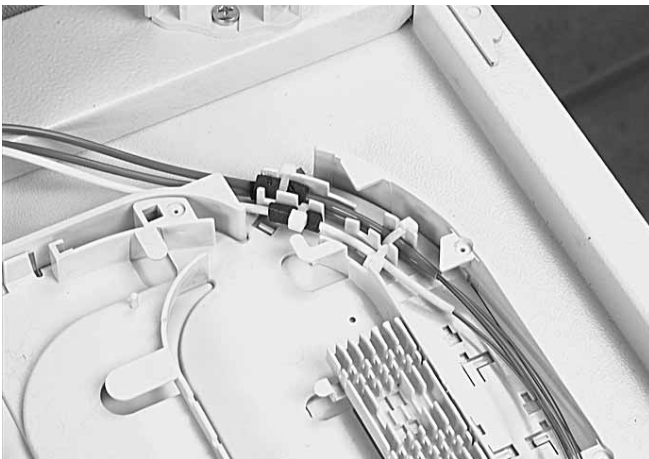

5.1.6 If necessary, tubes can be bundled with 1 foam. If loose tubes are added at a later date, use other positions.

5.1.9 Splice the fibers.



5.1.10 Place the splice protector in the holder, start at outside of the tray, (hold the splice holder with finger to prevent bending) and coil the fibers in the tray.

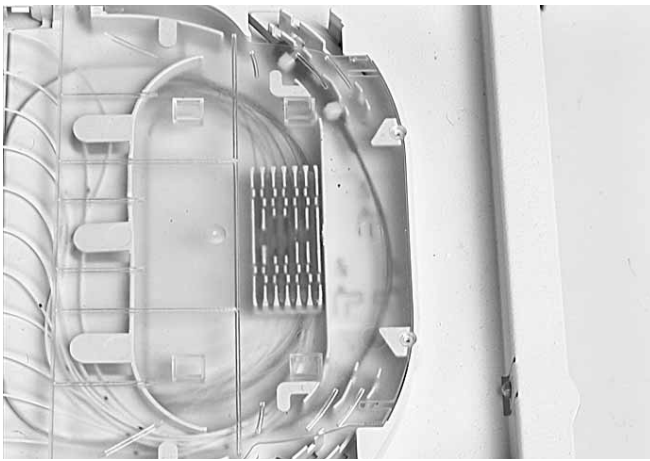

5.1.11 Check whether all fibers are properly routed before placing the cover on the tray. All fibers should be under the containment lips.

24 splice module



5.1.12 Strip the loose tubes and place 1 layer of foam around all the tubes at 50 mm from the end of the tubes.



5.1.13 Secure all the tubes with the two tie-wraps as shown.

In case not all fibers will be installed at day 1

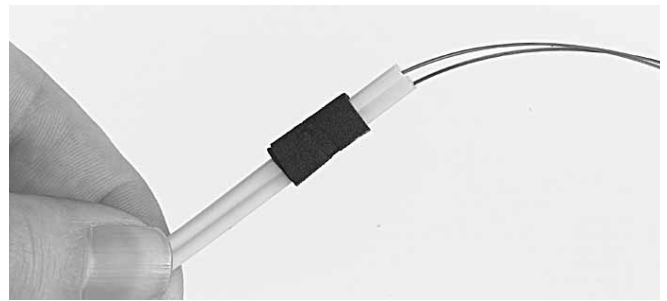

5.1.14 Strip the loose tubes and place 1 layer of foam around the tubes at 10 mm from the end of the tubes.

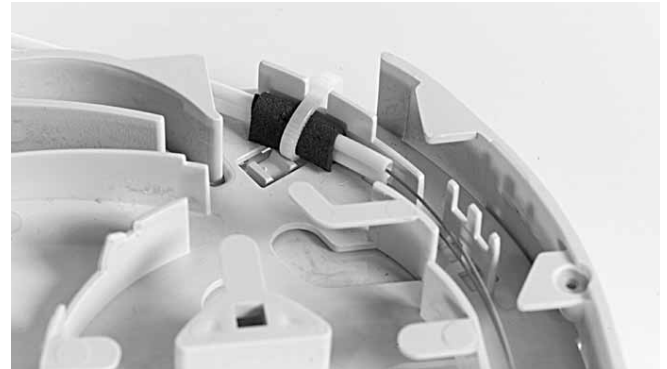

5.1.15 Secure all the tubes with one tie-wrap as shown.

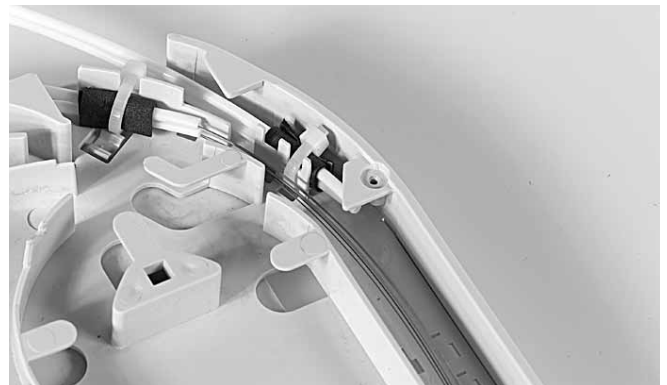

5.1.16 Secure the added tubes also with one tie-wrap as shown. Preparation is the same as the first installed tubes.

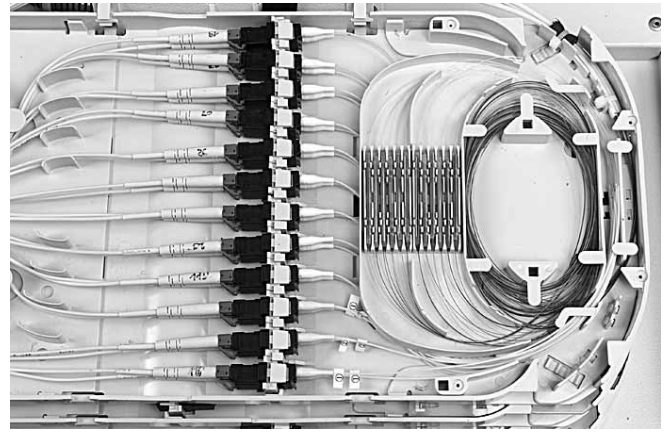
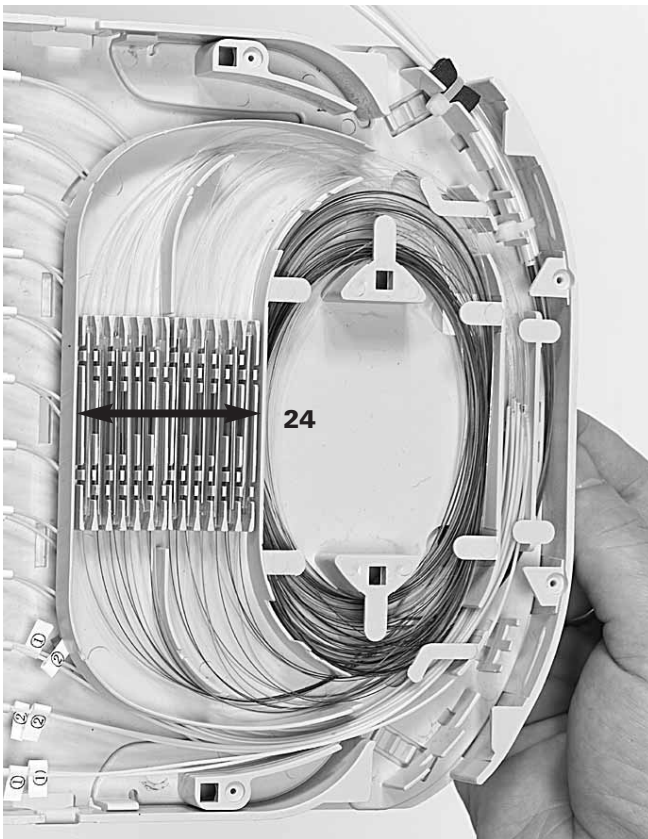

5.1.18 Splicing and storage.

5.2 Installation of IFC on the tray

12 splice module

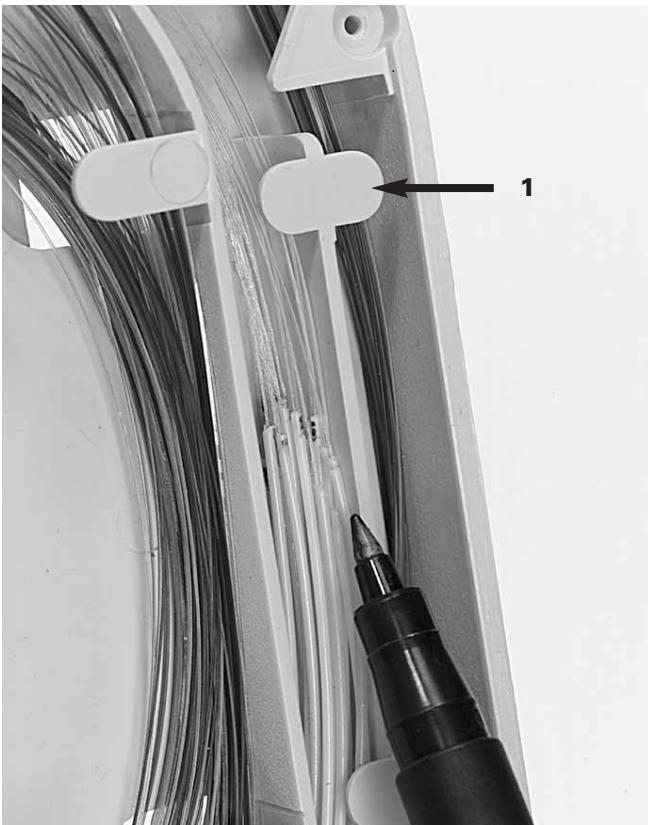

5.1.17 The split transition plate (1) separates the incoming fiber and the 900 μm coming from the patch panel. Strip the 900 μm somewhere in the middle of the groove. Stripping should always be in a straight line. Not applicable with tight coated (900μm - storage max. 1.2 m), only semi-tight can be stripped.



5.2.1 For ease of installation start with the bottom tray. If possible apply 1 wrap of foam tape around the IFC, just before the jacket end (This foam prevents from easy pull-out and provides protection to the fibers inside). Attach to the tray with 2 small tie-wraps. At least 1 tie-wrap should be on top of the foam tape. Cut the excess length of the tie-wrap. Make sure the tie wrap knob is at the side of the IFC. Don't squeeze the fibers.

5.2.2 For IFC and pigtail management, leave sufficient slack so that the drawer can still be opened.

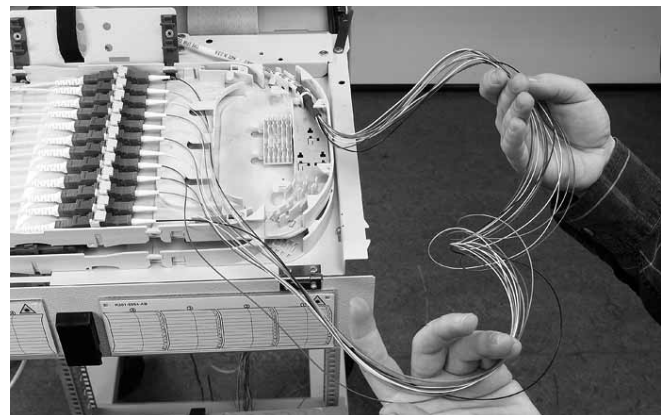

5.2.3 Plug the connectors into the appropriate connector adapters.

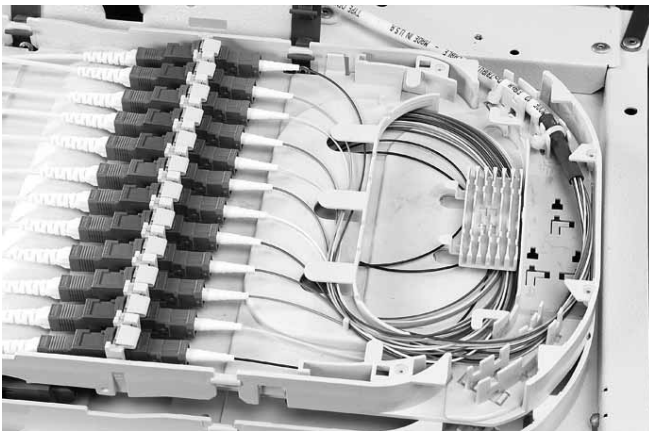

5.2.4 Now the IFC can be coiled into the slack fiber storage area. Fibers must be untangled before coiling.
Note: splicing repair connectors is possible; one can use the splice holder which is pre-mounted in the tray.

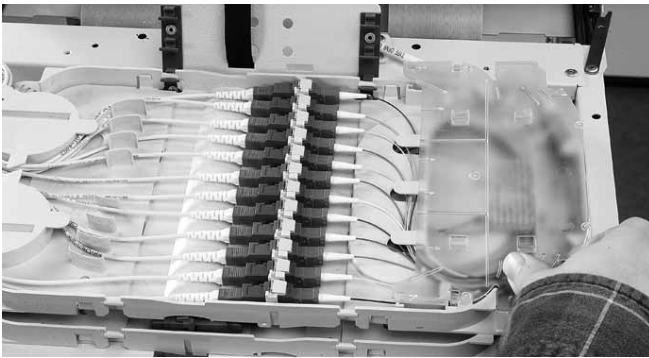

5.2.5 Check if all fibers are properly routed before placing the cover on the splice module. All fibers should be underneath the containment lips.

24 splice module

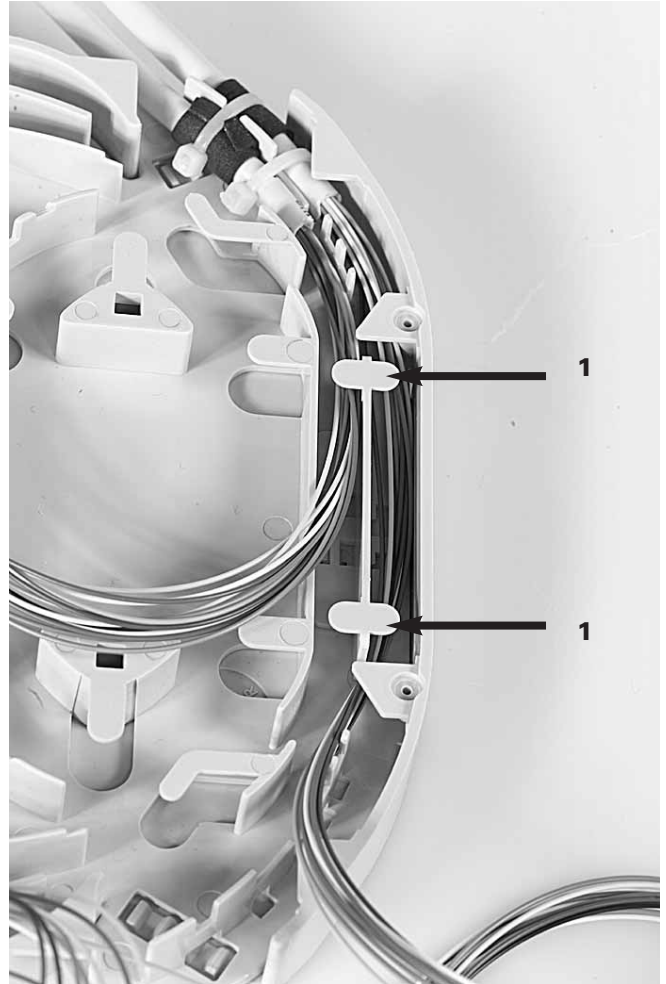

5.2.6 You can separate each bundle of 900 μm by the split transition plate (1).

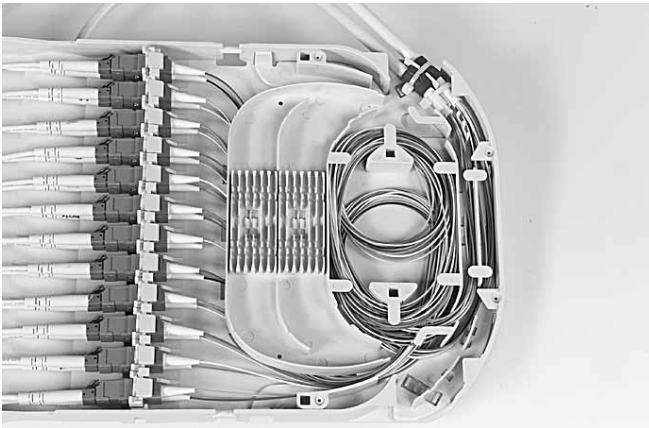

5.2.7 Install the connectors of the first bundle (1) in the adapters and then route the overlength in the storage area. Repeat this for the second bundle (2). Enter the storage area (see picture above).

5.3 Installation of break out cable/pigtail on the tray

GTU not applicable for the 24 splice module.

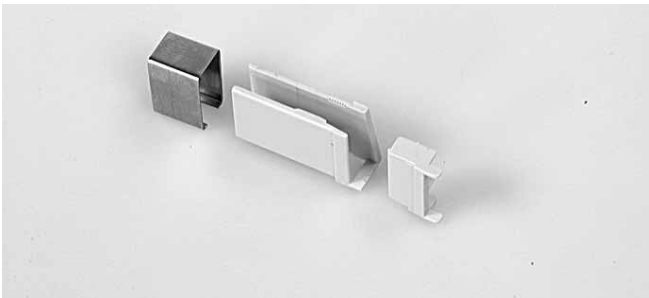

5.3.1 Use the GTU kit for the Kevlar termination of a group of 4 pigtails.

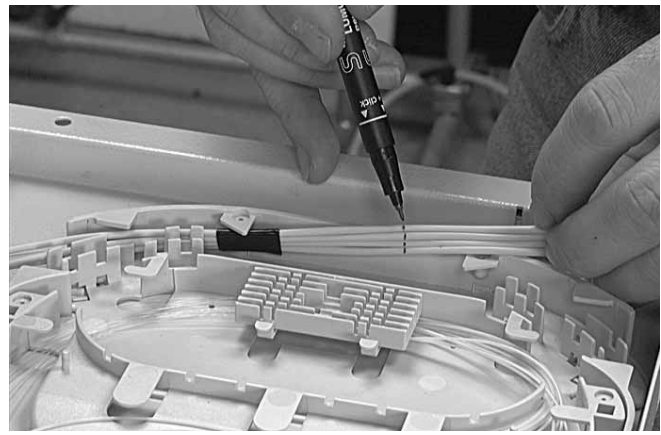

5.3.2 Identify the 4 pigtails. Bundle them with PVC tape. Route them up to the tray, mark the 4 pigtails on the GTU position. Make sure there is 1,5 m pigtail available from this point. The length is limited to 1 m in case of tight coated pigtail.

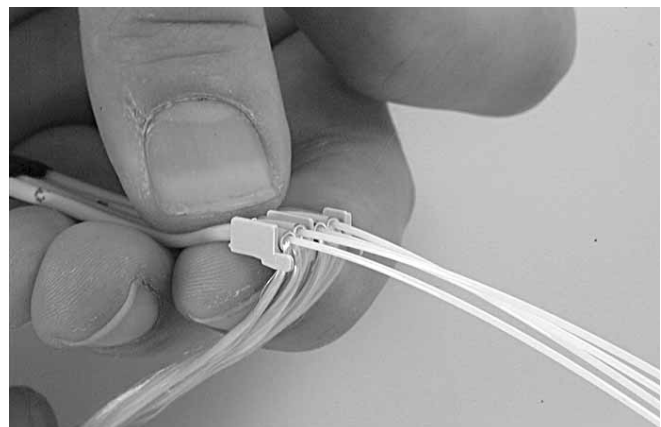

5.3.3 Strip the pigtail jacket at the marks. Cut the Kevlar to ± 100 mm. Bend the Kevlar over the edge of the inner part. Don't entangle the fibers, avoid crossings.

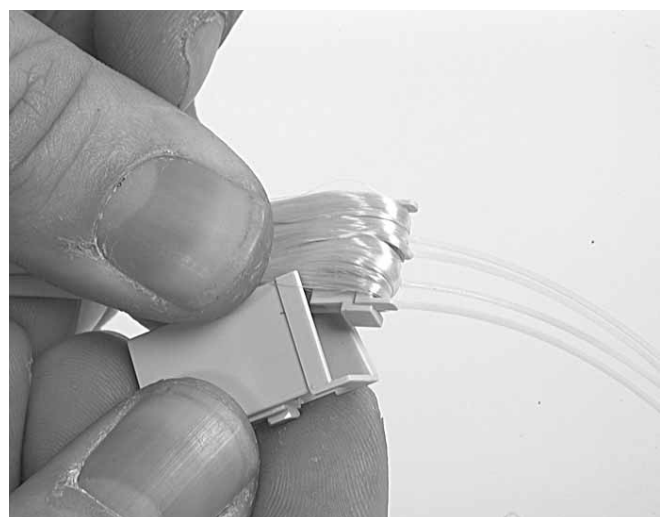

5.3.4 Slide the outer part over the inner part. Keep both parts under a certain angle as shown. Keep the Kevlar in position with your left thumb.

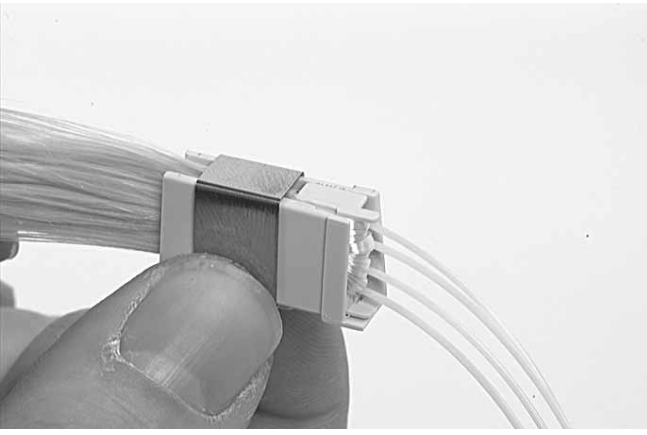

5.3.5 Slide the metal clip over the pigtails and then over the GTU, up to the front.

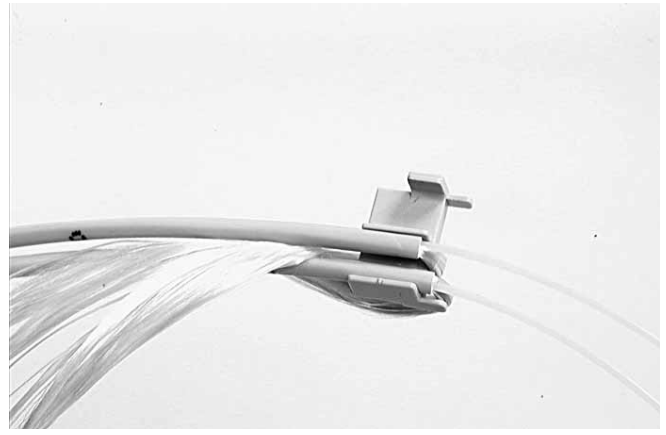

5.3.8 In case of pigtails with a limited amount of Kevlar (typical outside diameter < 2.4 mm): wrap the Kevlar twice around the inner part. Bring the Kevlar of 2 neighboring pigtails together and pass the Kevlar between both pigtails. Repeat for the 2 other pigtails. Always install 4 pigtails per GTU.

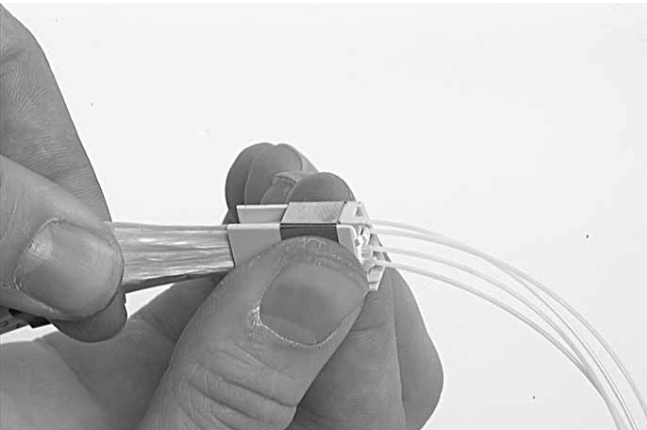

5.3.6 Take the GTU at the metal clip and pull at the Kevlar until it locks completely.

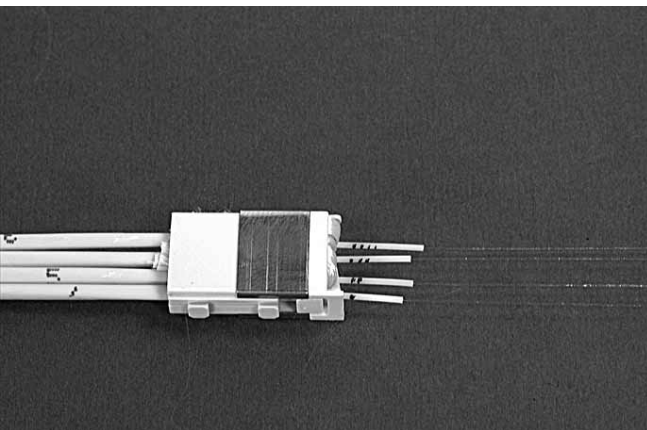

5.3.7 Cut excess Kevlar. Identify the pigtails. Remove the secondary coating 10-20 mm from the GTU (only possible in case of semi-tight pigtail). This ensures you the transition primary-to-secondary is in a straight line.

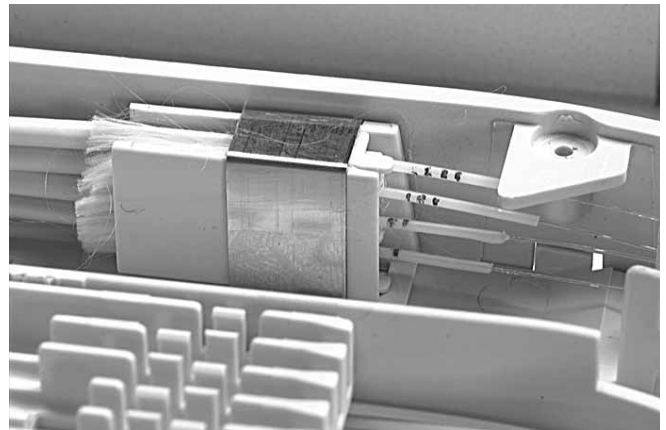

5.3.9 Mount the GTU. Start at the outside of the tray.

5.3.10 Strip the pre-mounted pigtails (see 5.1.7 - 5.1.8)

5.3.11 Splice the fibers. Place the splice protector in his holder, start at the outside of the tray (hold the splice holder with finger to prevent bending). Coil the fibers in the tray.

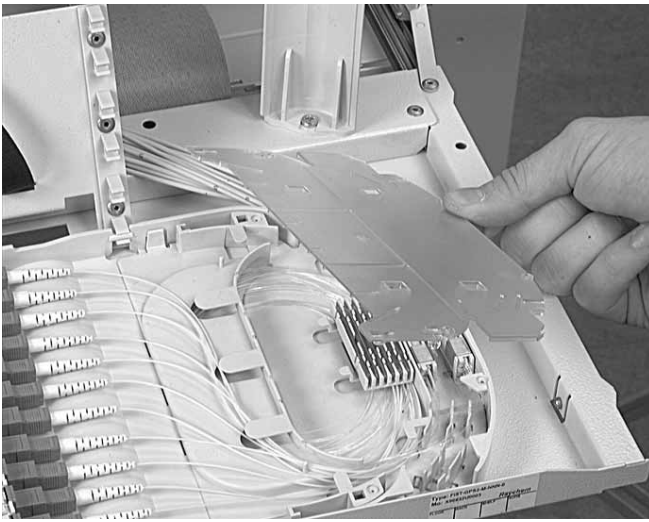

5.3.12 Check whether all fibers are properly routed before placing the cover on the module. Fibers can not be on top of containment lips.

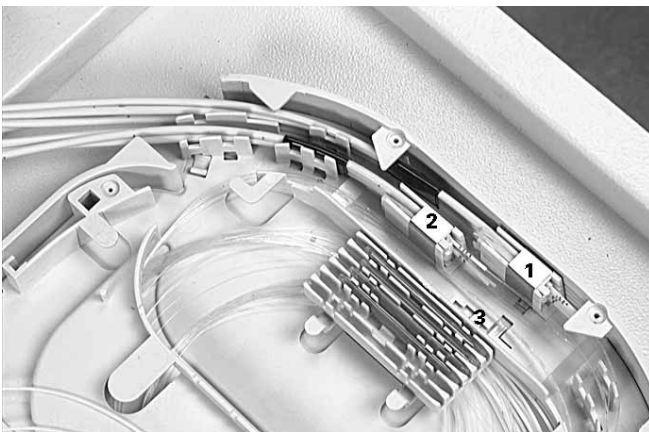

5.3.13 **Remark:** storing non spliced fibers.
When not all 12 fibers are spliced at once: route the non-spliced fibers on top of the stored fibers. Route them outside the storage zone to have easy access at a later date, without disturbing active circuits.

5.4 Installation of ribbon cable on the tray

12 splice module

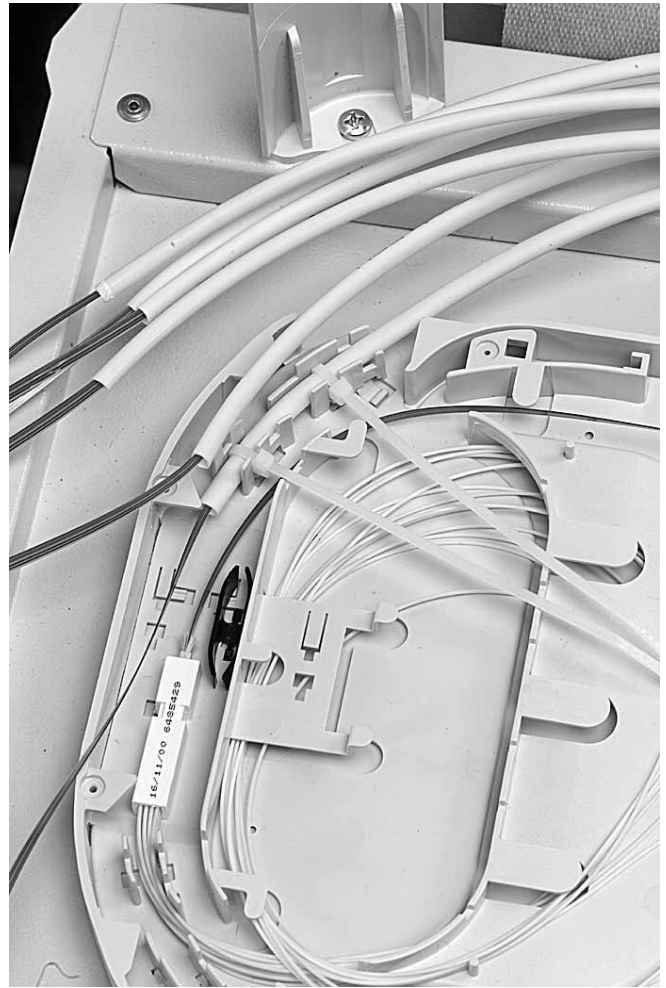

5.4.1 Fix the tubes in the middle position with tie-wraps. Don't squeeze the tubes.

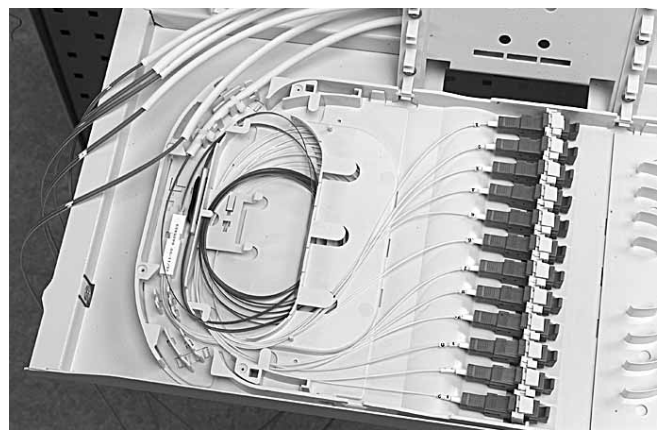

5.4.2 Make the splices and store the overlength without twists in the storage area.

5.5 Installation of ribbon pigtail on the tray

12 splice module and 24 splice module

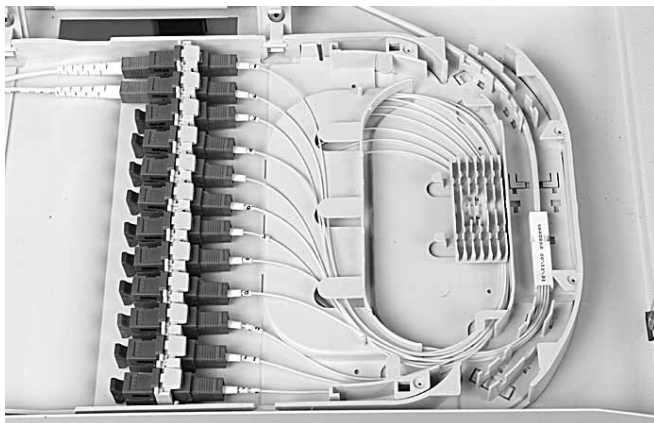

5.5.1 Always pre-installed, route the ribbon pigtail to the splicing shelf (GSS2)

6 Storage

Storage capacity

Pigtail Ø	Length	Number of trays
1.7 mm	1.5 m	4 trays (96 connectors)
2.4 mm	3 m	4 trays (48 connectors)
2.8 mm	2 m	4 trays (48 connectors)

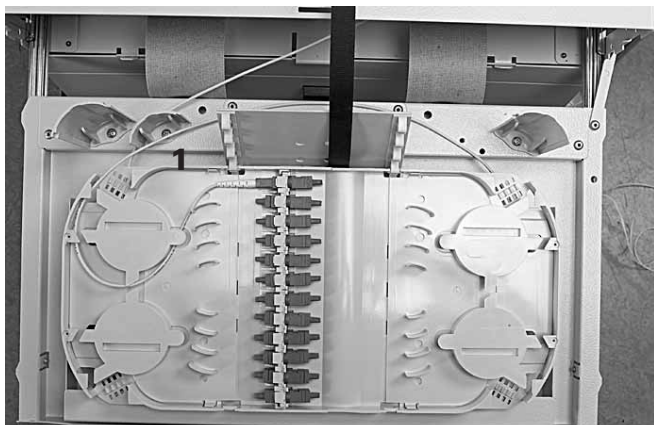

6.1 ETSI shelf: storage of a patch cord entering the shelf at the right side is shown. Check the position of the small bend control (1).

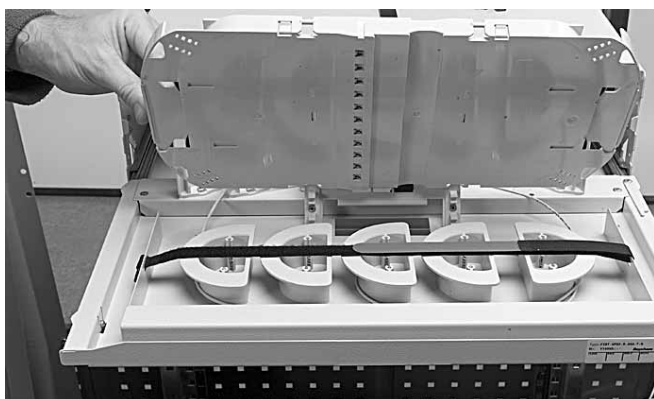

6.2 Route as shown. Secure with the Velcro.

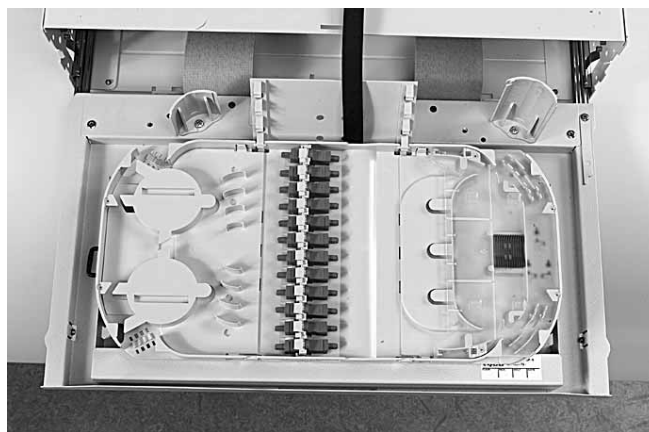

6.3 ETSI shelf with loose tube cable.

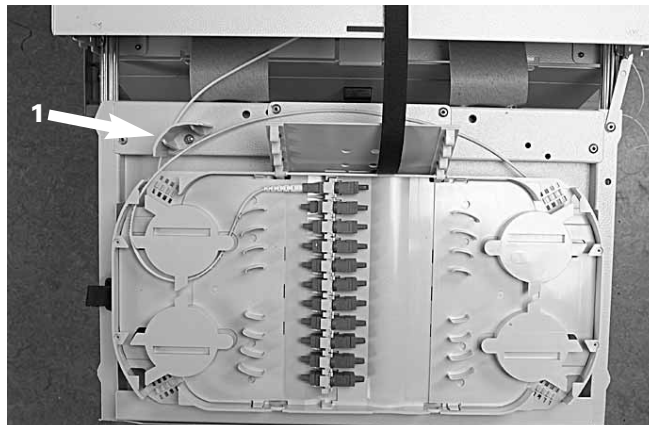

6.4 19" shelf: storage of a patch cord entering the shelf at the right side is shown. Check the position of the small bend control (1).

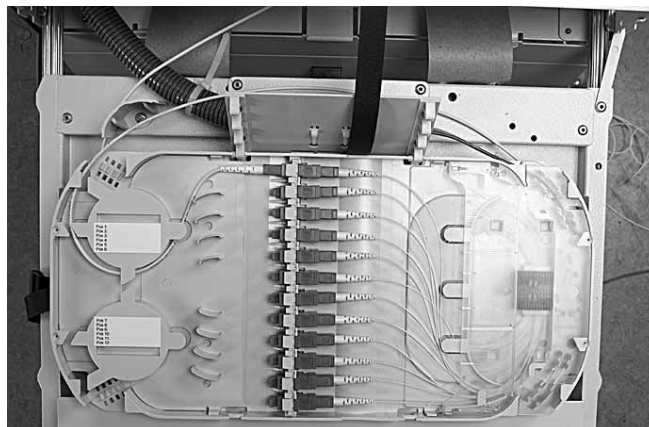

6.5 19" shelf with loose tube cable.

6.6 In case of patch cords entering at the left-hand side: position the small bend control at the right side.

7 Patching

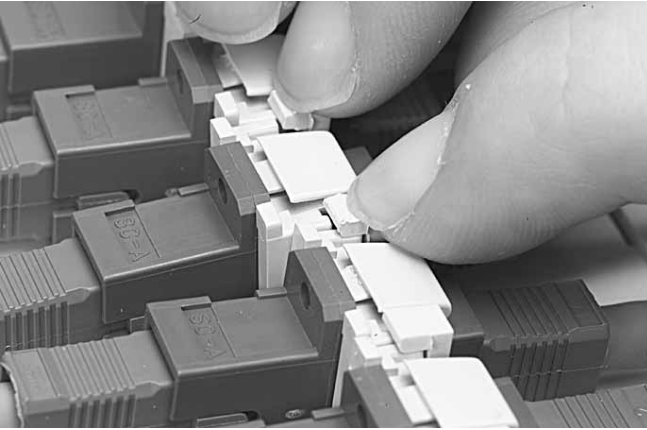

7.1 Route the jumper through the horn up to the tray. Remove the connector adapter out of the tray and mount the connector into it as described. Push the plastic hooks which hold the adapter away and push the adapter simultaneously in the opposite direction. Place the adapter + connector back in the tray by sliding and hinging it down along the vertical axis.

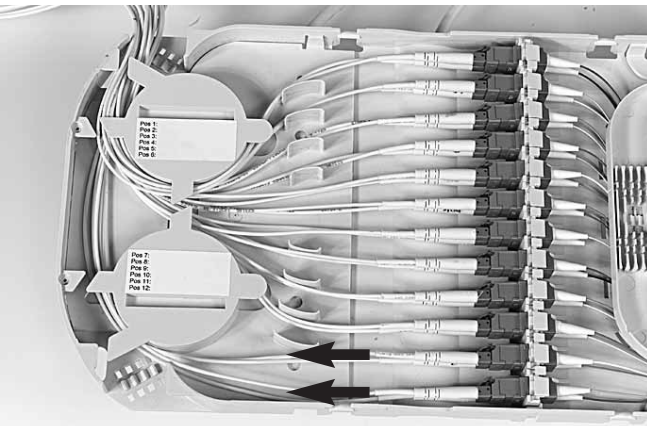
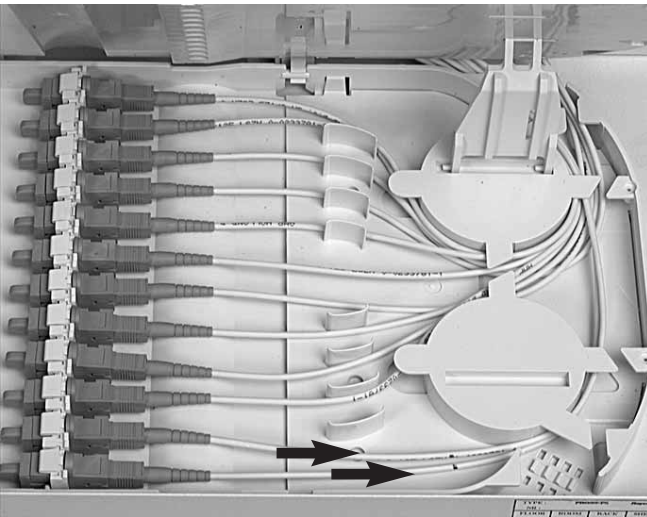

7.2 Repeat this procedure with the other pigtails. Respect routing of jumpers as shown on the picture. Provide sufficient slack for patching to all other positions in the shelf.

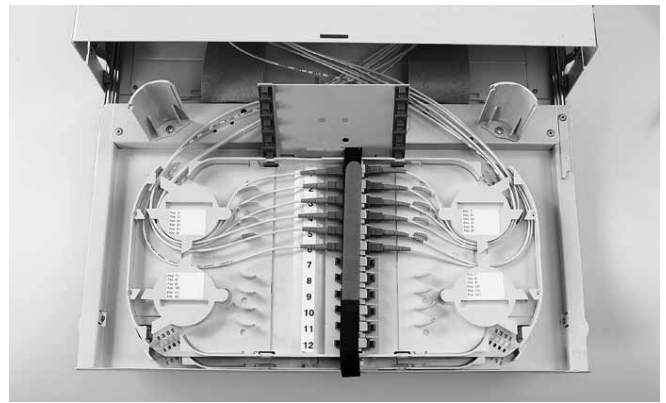

7.3 Routing of incoming pigtails and outgoing patchcords.

8 Closing the shelf



8.1 Place the labels and write down information.

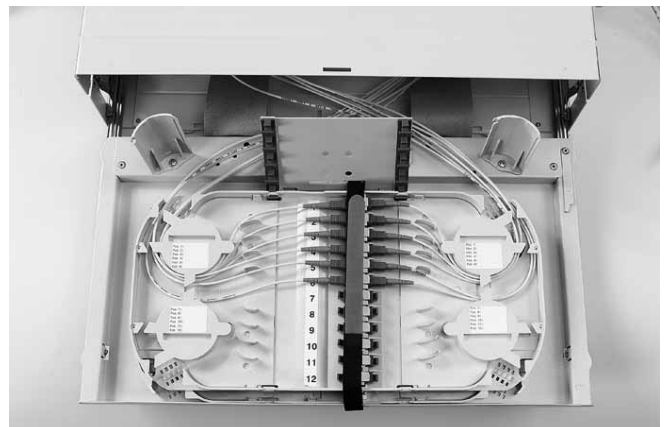

8.2 Picture showing all the available labels for identification.

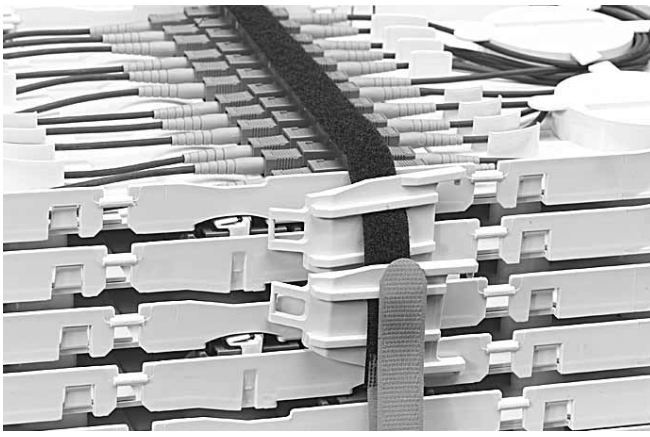

8.3 Place the tray wedges on the velcro and secure the trays with the velcro. Close the drawer after turning the security clip 180° and by pushing the spring on the right side of the shelf.



8.3 Identify the shelf.

9 Important steps

- In case of loose tube termination side or back
 - remove bend controls at the side of the cable entrance (19" shelves don't have bend controls)
 - don't modify the predefined flex tube length
 - apply foam tape to the flex tube
 - apply foam tape to loose tubes
- Make sure the transition primary-to-secondary fiber is in a straight line: under the splice holder (in case of tight coated pigtail: in the splice protector)
- Cut excess length of tie-wraps
- Make sure all fibers and pigtails are properly routed and are under the containment lips
- Bundle pigtails/patchcords with velcro; don't use tie wraps
- Try to store ribbons without twists.

Tyco Electronics Raychem bvba

Diestsesteenweg 692

B-3010 Kessel-Lo, Belgium

Tel.: 32-16-351 011

Fax: 32-16-351 697

www.tycoelectronics.com

www.telecomosp.com

SMOUV, FIST, das TE Logo sowie „Tyco Electronics“ sind eingetragene Warenzeichen der Tyco Electronics Unternehmensgruppe und ihrer Lizenznehmer. Kevlar, Teflon and Velcro are trademarks.

The information given herein, including drawings, illustrations and schematics which are intended for illustration purposes only, is believed to be reliable. However, Tyco Electronics makes no warranties as to its accuracy or completeness and disclaims any liability in connection with its use. Tyco Electronics' obligations shall only be as set forth in Tyco Electronics' Standard Terms and Conditions of Sale for this product and in no case will Tyco Electronics be liable for any incidental, indirect or consequential damages arising out of the sale, resale, use or misuse of the product. Users of Tyco Electronics products should make their own evaluation to determine the suitability of each such product for the specific application.