

## Fist Generic Splicing Shelf

### Contents

|                                    |  |
|------------------------------------|--|
| <b>1 Introduction</b>              | 4.2 Side cable termination directly on the shelf using cable termination plate |
| <b>2 General</b>                   | a Loose tube cable   |
| 2.1 Kit content                    | b Modular cable  |
| 2.2 Tools                          | 4.3 Back cable termination directly on the shelf using cable termination plate |
| <b>3 Installation of the shelf</b> | a Loose tube   |
| 3.1 Mounting the shelf in the rack | <b>5 Termination of the pigtails</b>   |
| 3.2 Preparation of the shelf       | <b>6 Splicing + storage</b>  |
| 3.3 Preparation of the trays       | 6.1 General  |
| a Cable to pigtail                 | 6.2 Ribbon   |
| b Cable to cable                   | <b>7 Closing the shelf</b>   |
| c Mounting the trays               | <b>8 Important steps</b>   |
| <b>4 Cable termination</b>         |  |
| 4.1 Cable termination in the rack  |  |
| a Loose tube cable                 |  |
| b Central core cable               |  |
| c IFC                              |  |

## 1 Introduction

### Product function

- The Generic Splicing Shelf is a multi-purpose mechanical shelf assembly for the FIST fiber management system in a rack environment.
- The product is typically used :
  - to store splices of external cable to external/indoor cable
  - to store splices of external cable to pigtails.
  - to store splices of pigtails to pigtails
- It can be installed in Tyco's FIST Racks and other 19" or metric (ETSI) rack sizes.
- Accessories are available for termination of most common cable types.
- Modular wraparound groove plates can be clicked in the UMS (Universal Mounting System) profile. They provide the foundation for mounting combinations of SOSA2 (Splicing Only Sub-Assembly) and/or SASA2 (Splitter Array Sub-Assembly) modules. Typically, Single Circuit or ribbon fiber management is used.
- Kevlar Termination Units (KTU's) can be mounted in the shelf to provide the necessary strain relief when terminating common pigtail types.
- The shelf is delivered with a metal hingable cover.

## 2 General

### 2.1 Kit content

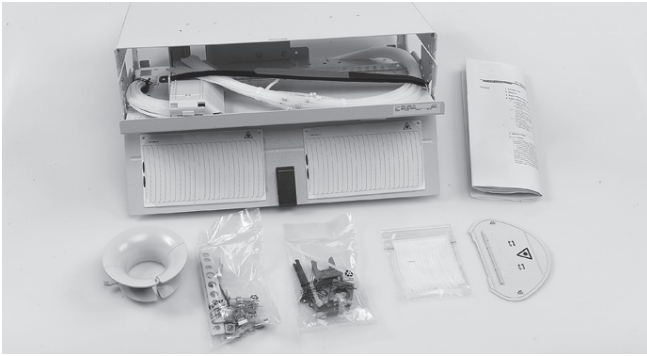

Kit content: example: FIST-GSS2-MA

- 1 shelf, incorporating
  - Metal chassis with drawer
  - Hingable and removable front cover
  - Pre-mounted tubes
  - Pre-mounted FAS block + cover
- 1 pigtail horn
- 1 tray lid + fiber guiding pin
- 1 cable entrance kit for 2 loose tube cables
- Cage nuts + bolts
- Mounting brackets + screws
- FOPT CT transportation tubing
- Installation instruction

### 2.2 Tools

- FACC-ALLEN-KEY-5-350 to mount shelf in the rack
- FACC-CAGE-NUT-TOOL for easy installation of cage nuts in the rack
- FACC-TUBE-CUTTER-01 cutter for transportation tubes
- FACC-TUBE-STRIPPER-02 loose tube stripper
- FACC-FIBRE-FEEDER
- Marker pen

## 3 Installation of the shelf

### 3.1 Mounting the shelf in the rack

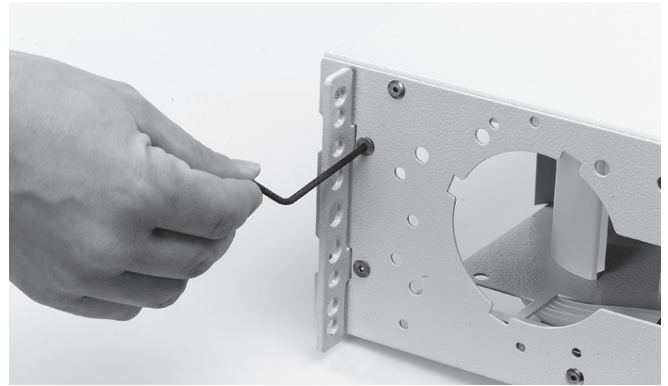

3.1 Install the mounting brackets on the correct position.  
GR mounting is shown.



3.1.2 Determine the position of the shelf (see rack installation instruction). Fix the cage nuts into the rack mounting uprights.

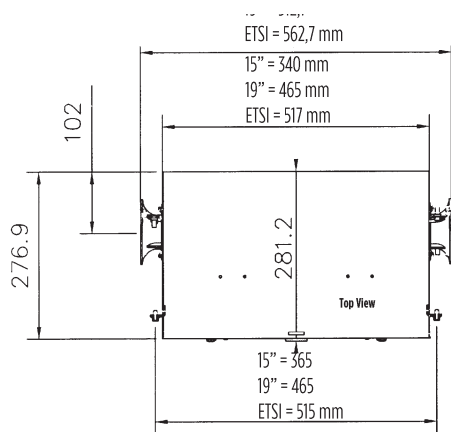
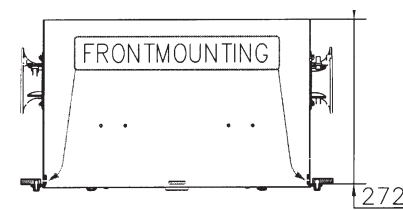
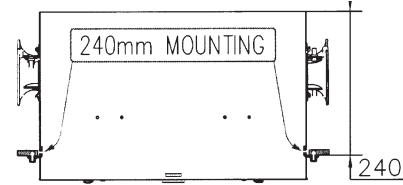
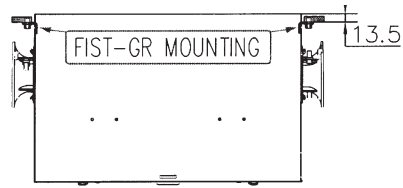
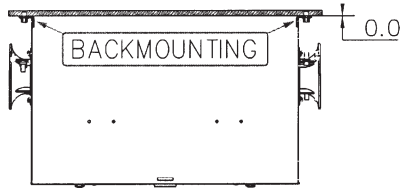

3.1.3 If a non-Tyco rack is being used it is possible that the cage nuts may not fit. In this case use locally supplied ones and install in accordance with local practices. Observe and respect minimum dimensions of the shelf.



3.1.4 Mount the shelf using the FACCC-ALLEN-KEY.

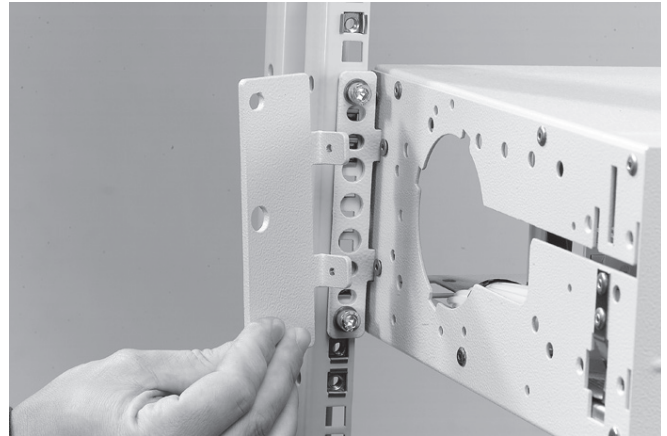

3.1.5 If necessary mount the adaptation brackets 19"-ETSI (FIST-MB2-M or FIST-MB2-M-AS).

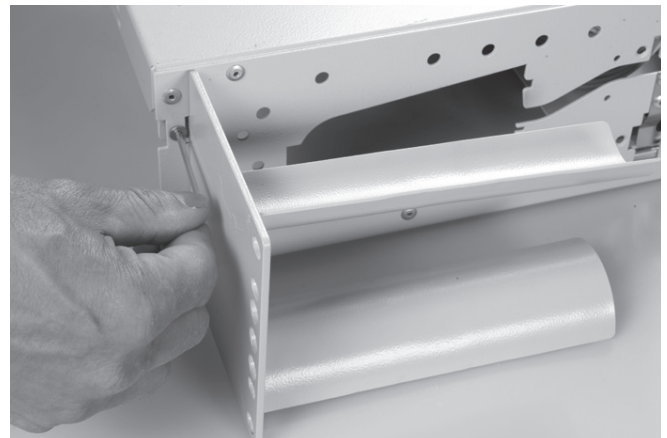

3.1.6 If necessary mount the 15"-ETSI adaption brackets.

### 3.2 Preparation of the shelf

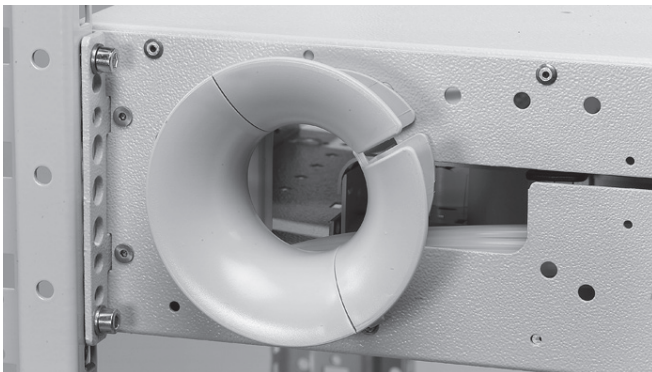

3.2.1 Install the trumpet by positioning it centrally in the opening at the side of the shelf, align the small knobs with the slots in the side, Strongly push and turn until the locking pin clicks into positioning hole.

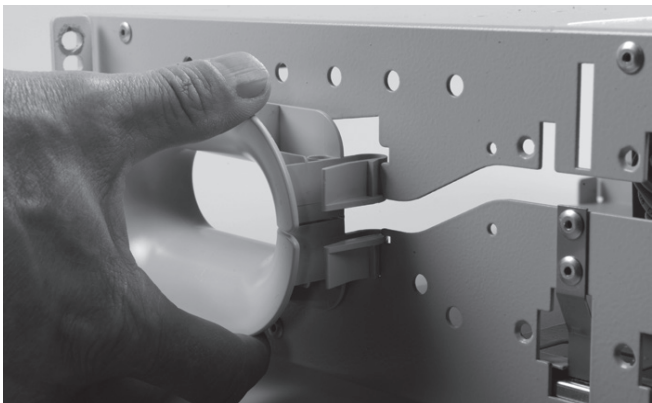

3.2.2 In case of 15", hook and click the horn in place.



3.2.3 The horn can be opened by pushing the upper part and clicking it.

### 3.3 Preparation of the trays

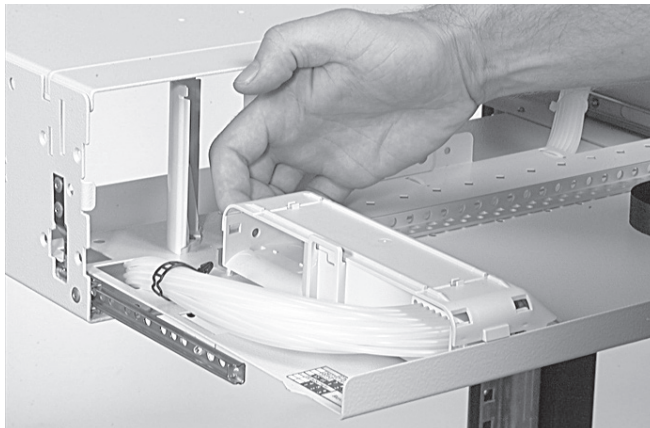

3.3.1 Pull the drawer to the fully open position. Remove the Velcro and the FAS block cover by lifting the back side of the cover.

#### a) Cable to pigtail

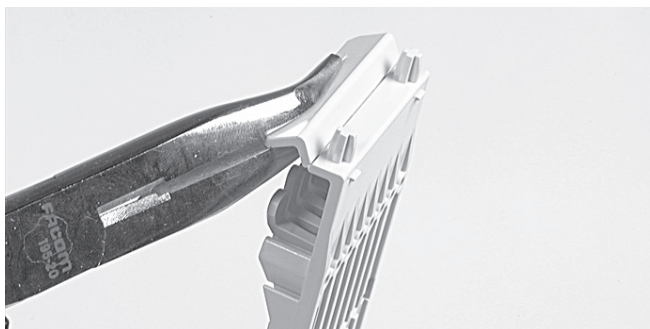

3.3.2 Remove the plastic piece at one side of the groove plates using pliers.

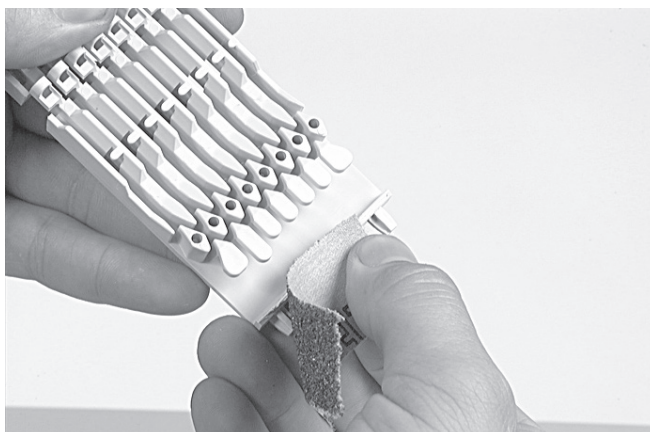

3.3.3 Remove sharp edges.



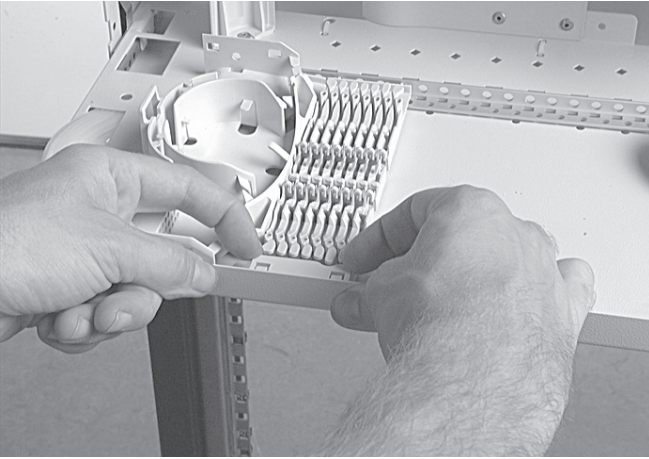
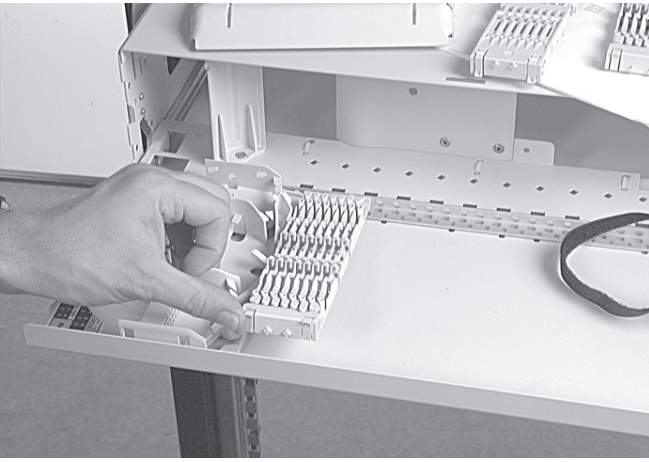

3.3.4 Click the groove plates on the aluminum profiles starting from the FAS block; don't leave any gaps. First position the pins of the groove plate at the back and pull the groove plate to the front until it locks.

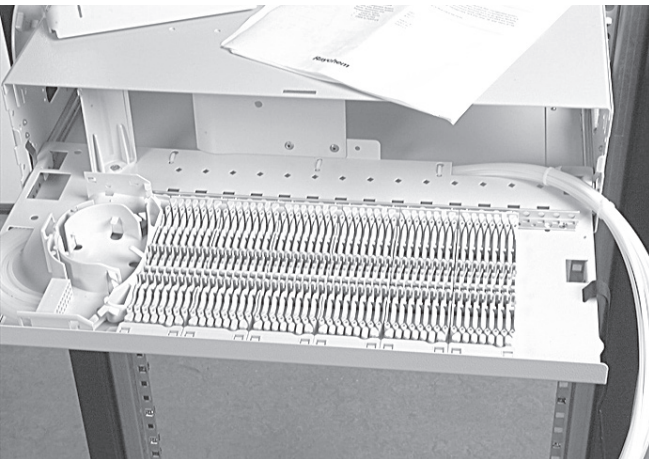

3.3.5 Depending on the configuration: fill up the shelf with groove plates, don't leave any gaps.

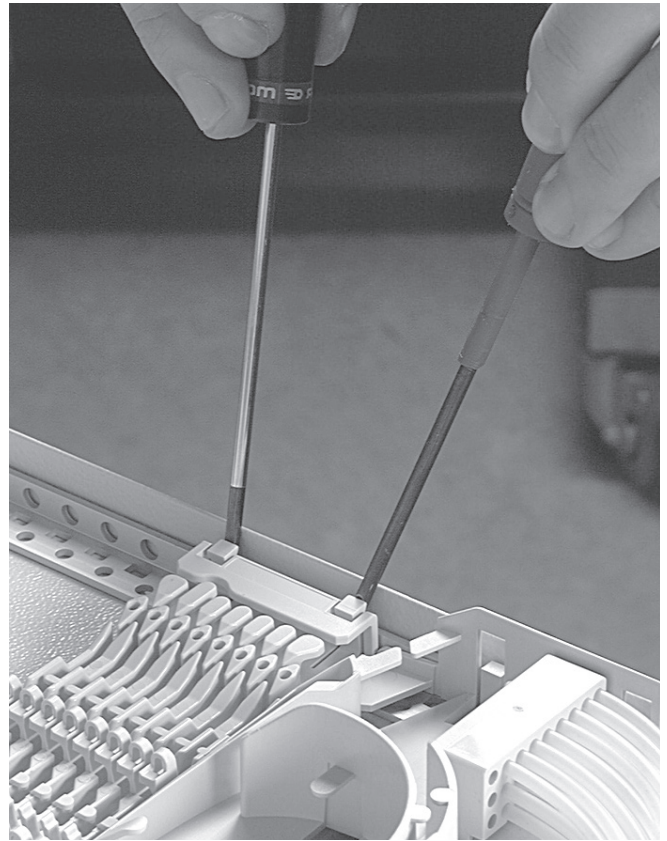

3.3.6 If necessary, the groove plates can be removed using 2 flat screwdrivers.

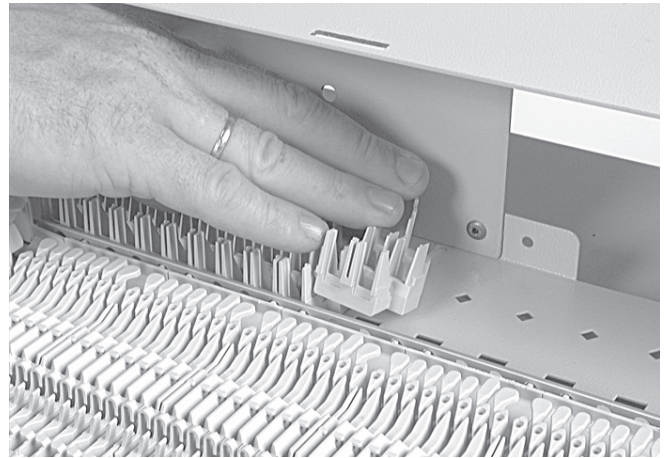

3.3.7 Mount the KTU brackets. Start at the left. Push until they lock.



## b) Cable to cable

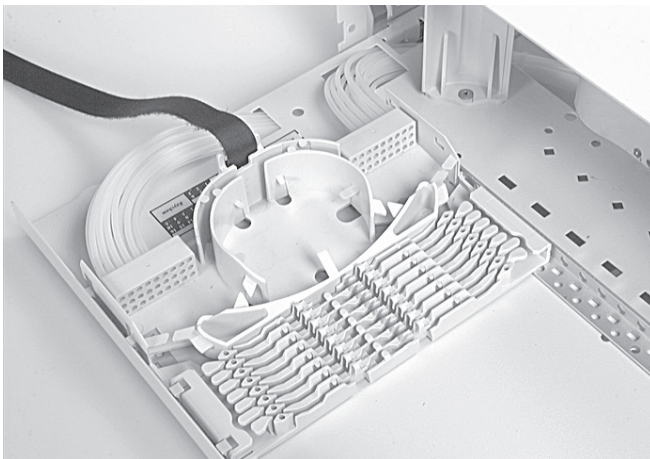

3.3.8 In case of a pure cable-cable configuration: no KTU-brackets are placed, the groove plates are not modified, tubes enter at both sides of the FAS block.

## c) Mounting the trays

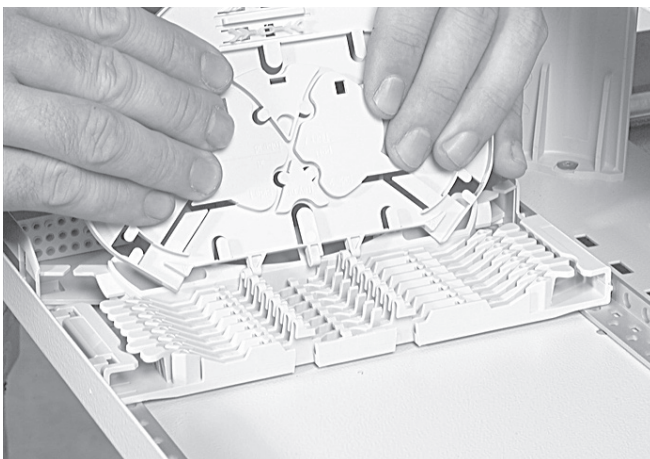

3.3.9 Click the trays on the groove plates starting from the fasblock. Preferably mount the trays as you fibre up. In case of SC trays (single circuit trays); don't leave any gaps.

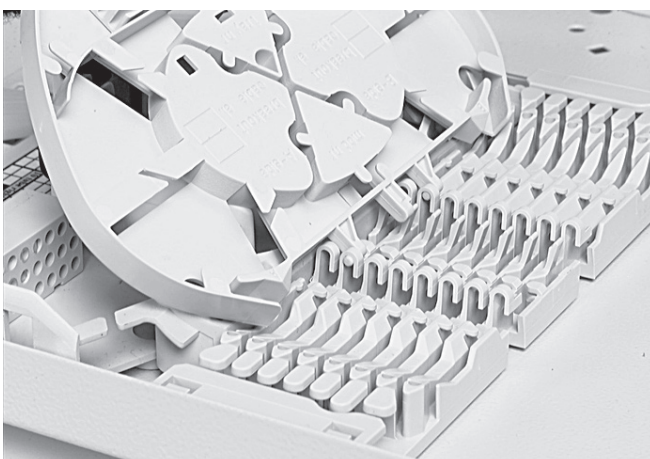

3.3.10 In case of SE trays (single element trays), start at the second position and leave 1 space between all the other trays.

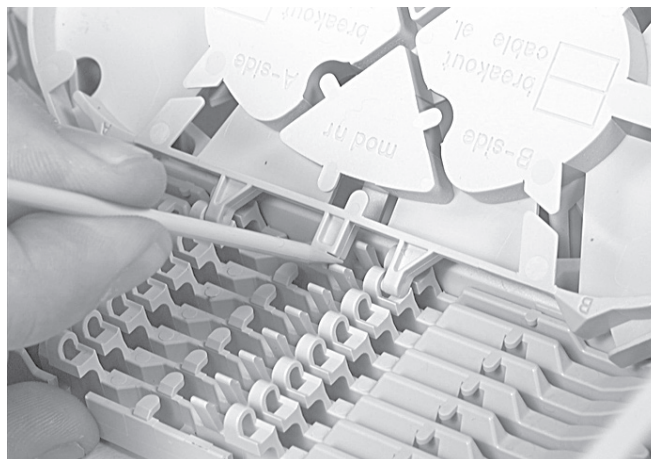

3.3.11 If necessary, trays can be removed using the fiber guiding pin.

## 4 Cable termination

### 4.1 Cable termination in the rack

Cable is already terminated in the rack (or in the side duct of the rack) on the cable termination plate. For the loose tube cable, the tubes are protected from the cable termination plate with the flex tube. For central core cable, fibers are guided into guiding tubes going directly into the shelf.

#### a) Loose tube cable

4.1.1 Take the tubes out of the unit. To avoid kinking of the tubes make sure the drawer is closed. To assure correct bend radius: do not reposition the fixed tie wrap.

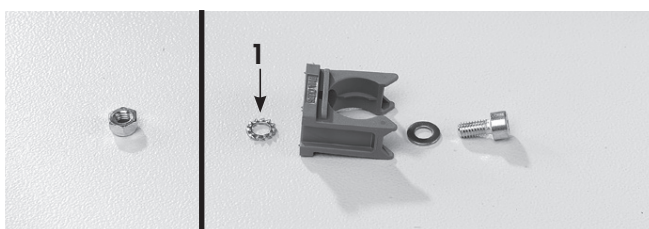

4.1.2 Mounting position: position the toothed lock washer (1) between the tube holder and the side plate.

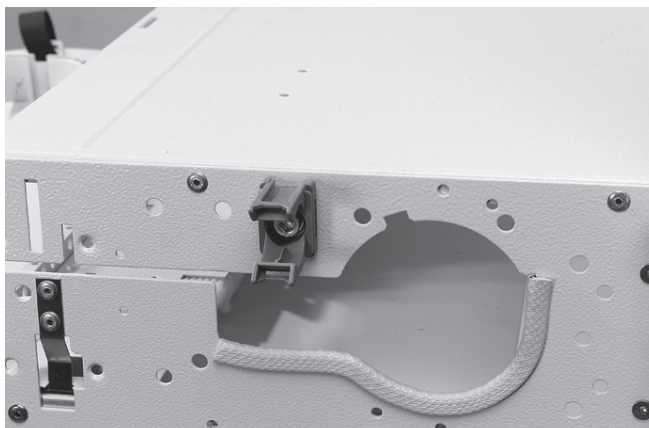

4.1.3 For back and GR mounting: mount the flex tube holder in the third hole from the front.

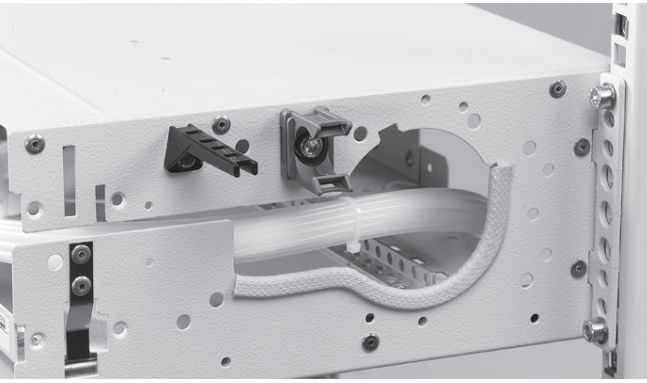

4.1.4 In case 2 flex tubes will be used: remove the releasable tie-wrap and mount the plastic stand-off in the first hole from the front.

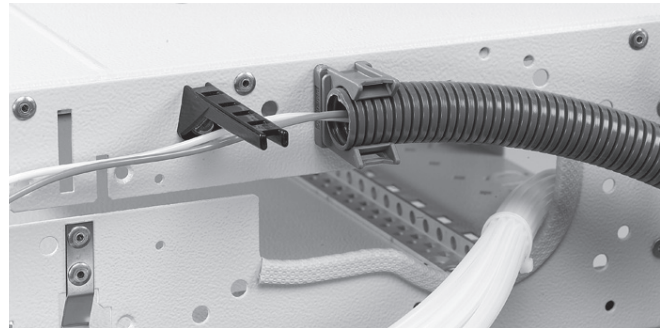

4.1.8 Bring the flex tube into the flex tube holder.

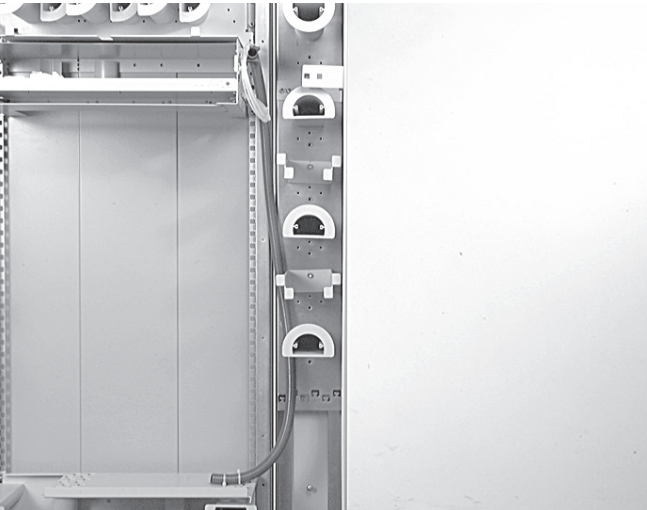

4.1.5 Prepare a piece of flex tube going from the cable termination plate in the rack to the flex tube holder on the shelf.

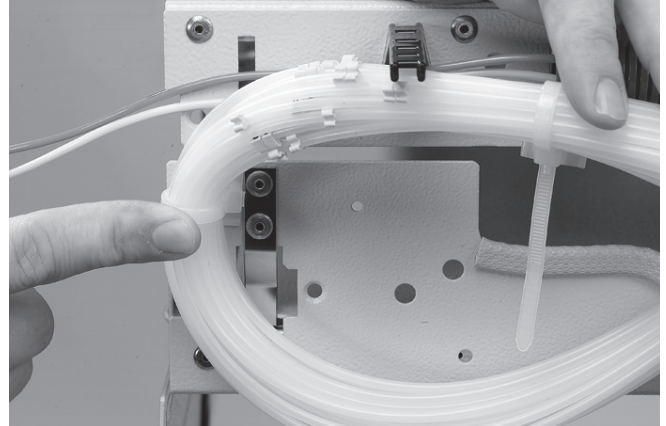

4.1.9 Mount the fixed tie wrap at the position as shown.

4.1.6 Cable and strength member termination will usually be done in the rack. Terminate the cable in the rack according to Tyco rack installation instruction and local practice. Leave 3.5 m of loose tube measured from the end of the flex tube.

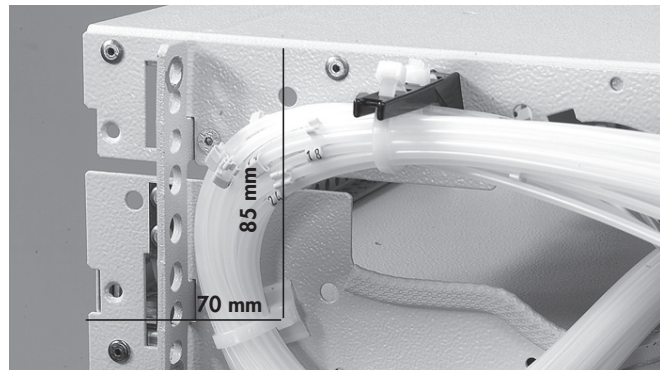

4.1.10 In case of front mounting of the shelf: mount the fixed tie wrap as shown.

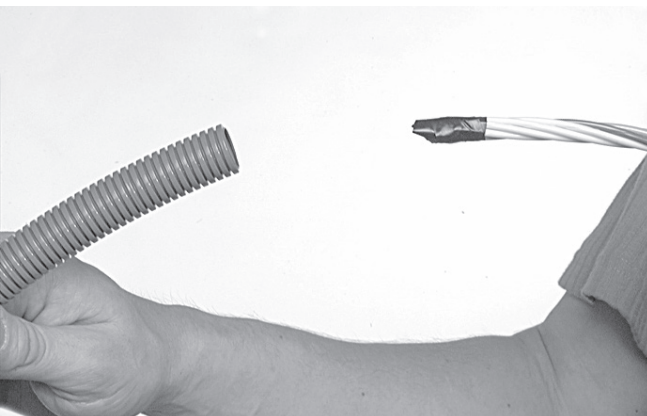

4.1.7 Identify the loose tubes and feed them through the flex tube. Wrap PVC tape around the tubes at the end of the cable to make feeding easier.

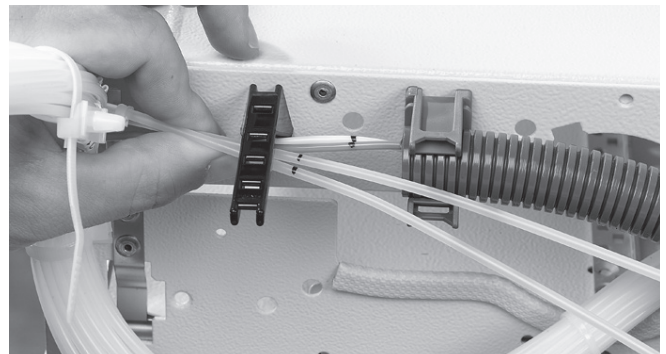

4.1.11 Mark the transportation tube at 30 mm from the end of the flex tube. Mark the loose tube at 20 mm from the end of the flex tube. Note: if the loose tube diameter is < 2,3 mm, the use of the FOPT-CT is not needed. Mark the transportation tubes at the end of the flex tube.



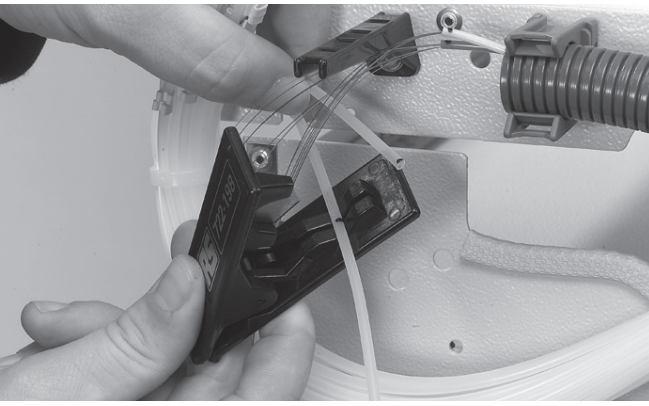

4.1.12 Strip the loose tubes from the mark and cut the overlength of the transportation tubes. Clean the fibers very well to make feeding easier.

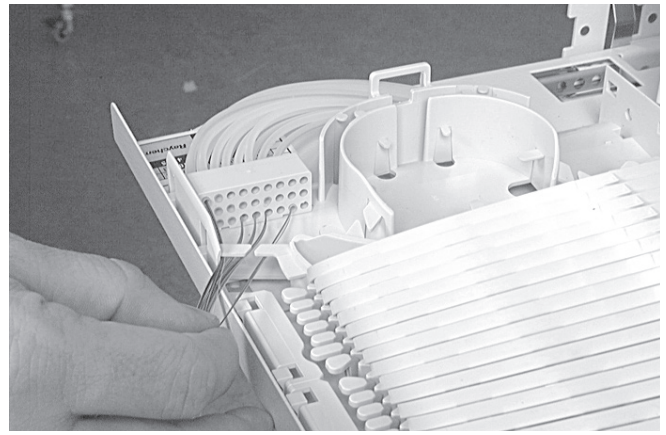

4.1.15 Pull the fibers at the other end of the tubes.

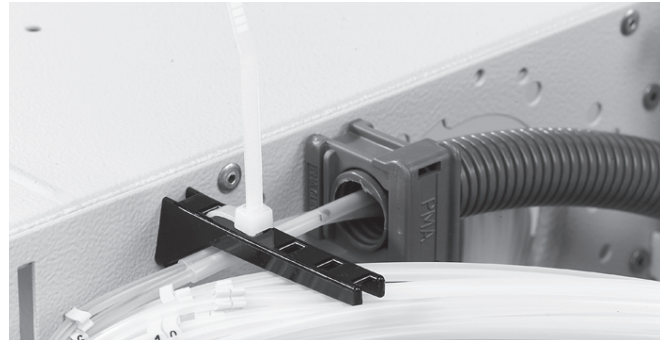
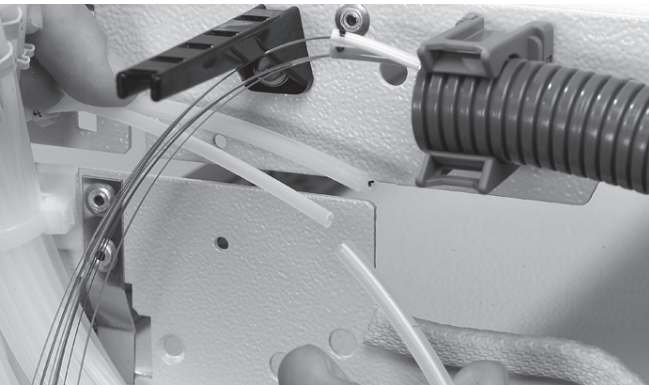

4.1.16 If no more loose tubes have to be terminated, cut the unused tubes. Secure the tubes with a tie-wrap.

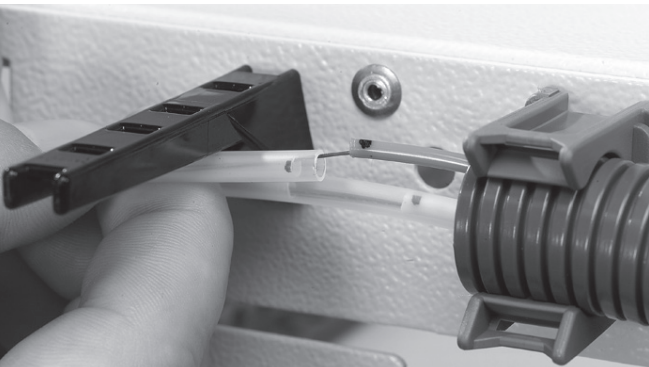

4.1.13 Select a loose tube and slide a 75mm long FOPT-CT over the transportation tube and loose tube or the transportation tube directly over the loose tube.

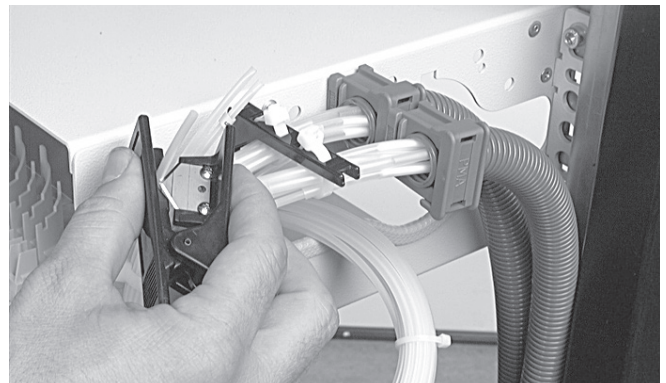

4.1.17 A second cable can be added using the second flex tube holder.

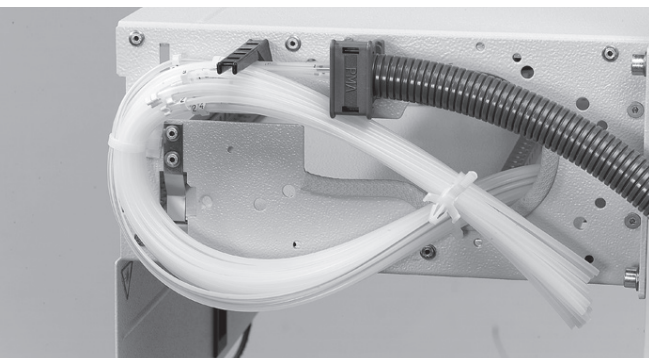

4.1.14 Route all tubes underneath the plastic stand-off and close the flex tube holder with the cover.



**b) Central core (single fiber or ribbon) and loose tube ribbon**

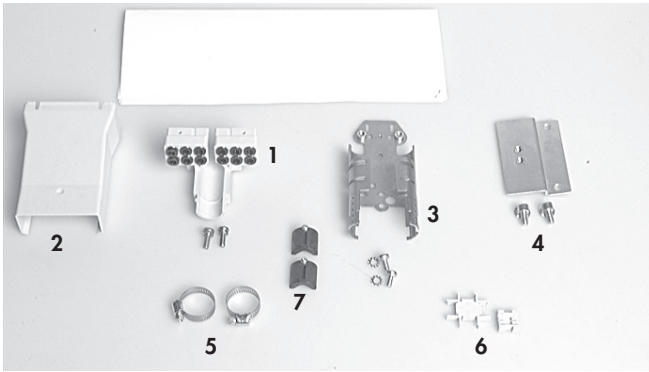

FIST-GR-CTB100CC (central core)

- 1 Breakout device
- 2 Breakout device cover + screws
- 3 Cable bracket + screws
- 4 Mounting bracket + washers + screws
- 5 2 cable clamps
- 6 Unraveling tool
- 7 2 strength member stops + screws

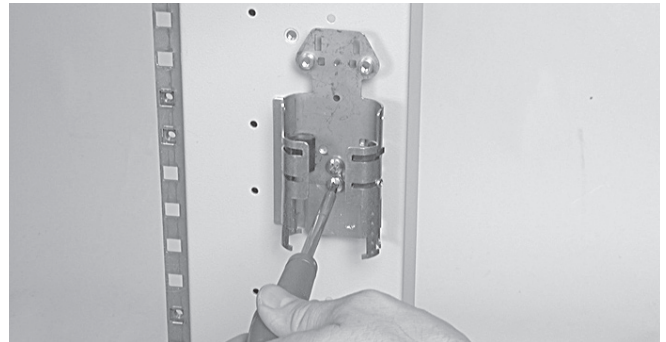
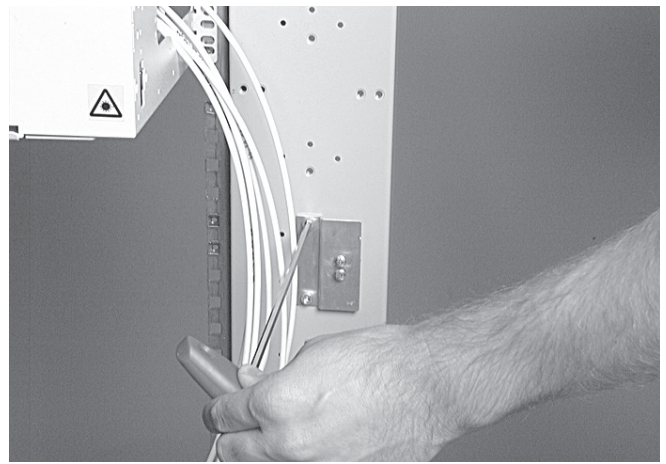

4.1.18 Choose a position in the side duct or on the cable termination plate as close as possible to the GSS. Mount the mounting bracket on that position with the two screws. Mount the cable bracket with two screws on the mounting bracket.

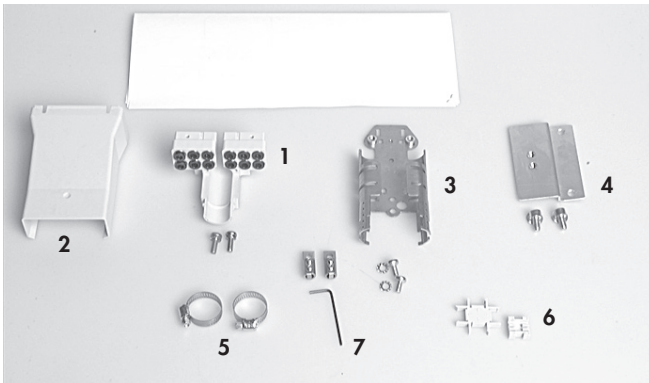

FIST-GR-CTB100 (loose tube ribbon)

- 1 Breakout device
- 2 Breakout device cover + screws
- 3 Cable bracket + screws
- 4 Mounting bracket + washers + screws
- 5 2 cable clamps
- 6 Unraveling tool
- 7 2 strength member terminations + screws

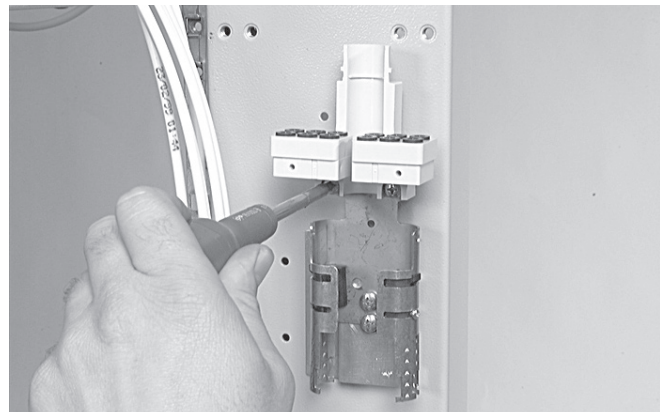

4.1.19 Place the breakout device on the cable bracket.

4.1.20 Prepare the cable. Make sure you have 3,5 m fiber inside the shelf. Respect dimensions shown on the drawings. Clean the fibers very well to make easy feeding possible.

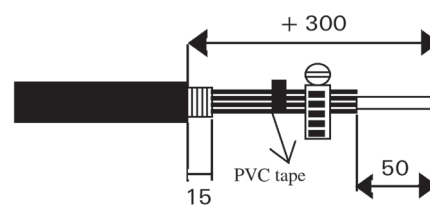

4.1.21 Loose tube ribbon cable.

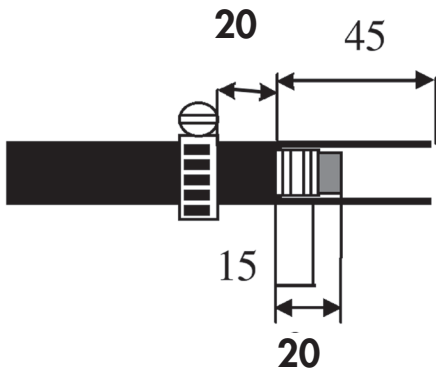

4.1.22 Central core cable

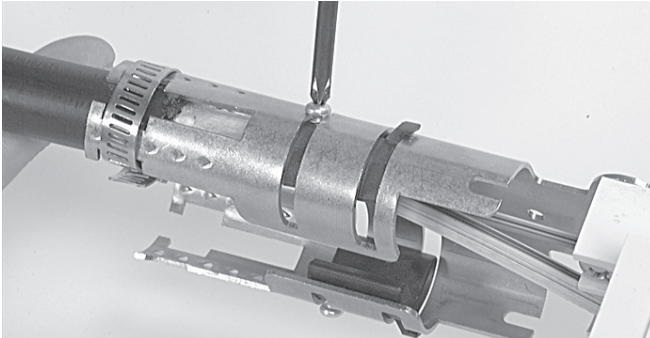

4.1.23 In case of central core cable: loosen the screw of the strength member stop. Rotate the stop and position the strength members.



4.1.24 Secure with the cable clamp. Don't squeeze the cable.

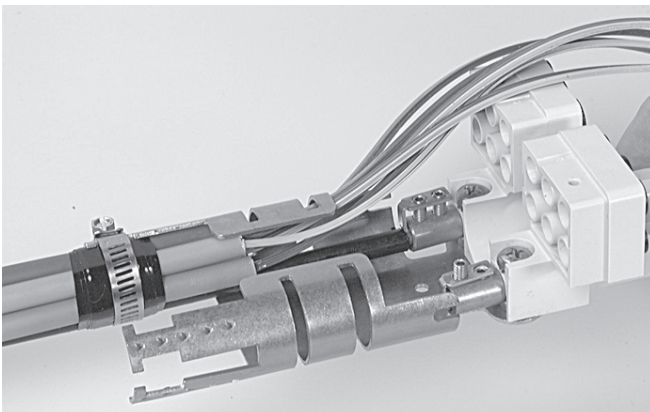

4.1.25 In case of loose tube cable  
Position the strength member at the bottom. Bundle the loose tubes with tape. Secure the strength member with the screws.

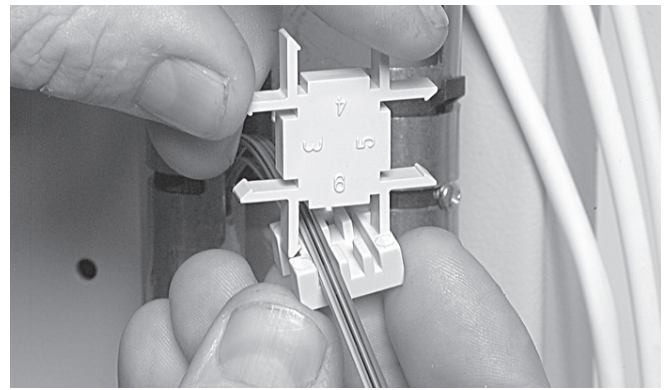

4.1.26 In case of ribbon cable

Remove twists in the ribbons.

- If ribbons are according ITU norms: use the unraveling device. The numbers indicate the number of ribbons you want to bundle (3-4-5 or 6). 3 sizes of ribbon can be handled: ribbon 12, 8 and 4. (3 groove sizes).
- In other cases use local practice.

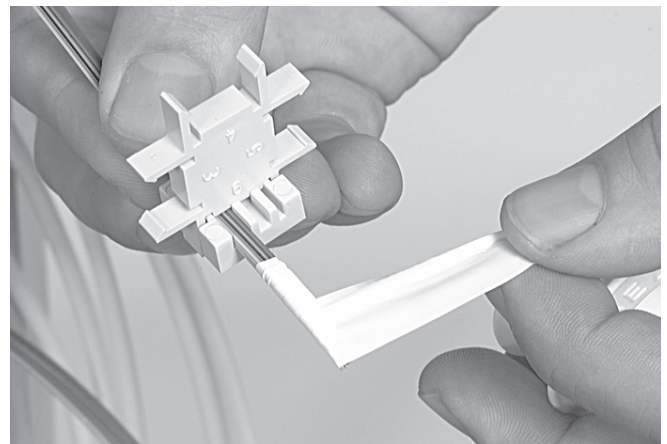

4.1.27 Slide the tool over the ribbons. Bundle at the end using Teflon tape (bundle in groups as you want to feed them through the tubes). Remove the unraveling device.



4.1.28 Cut the tubes to length using the tube cutter. Make sure the shelf is in an opened position.



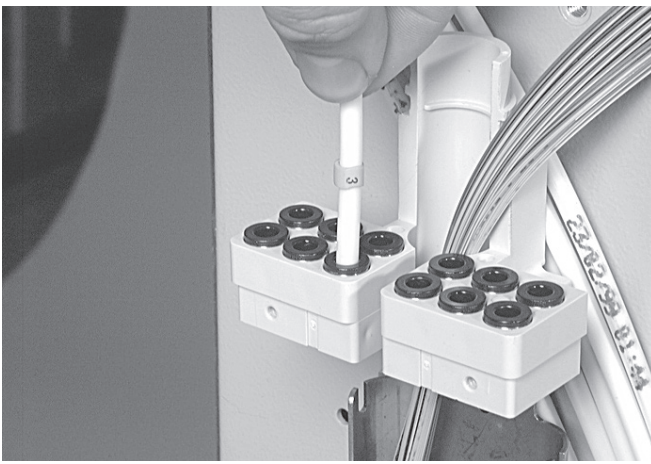

4.1.29 Insert the tubes in the connectors. Use 6 positions at the left when cable is mounted at the left side of the bracket.

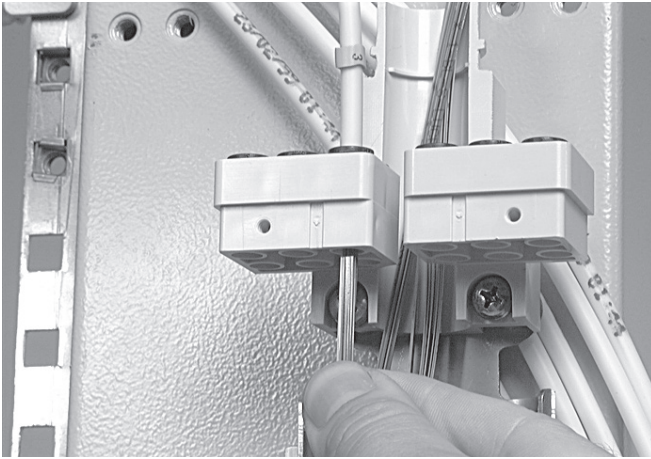

4.1.30 Feed the fiber groups in the tubes. Start at the back to have easy access. Avoid crossings of the fibers.

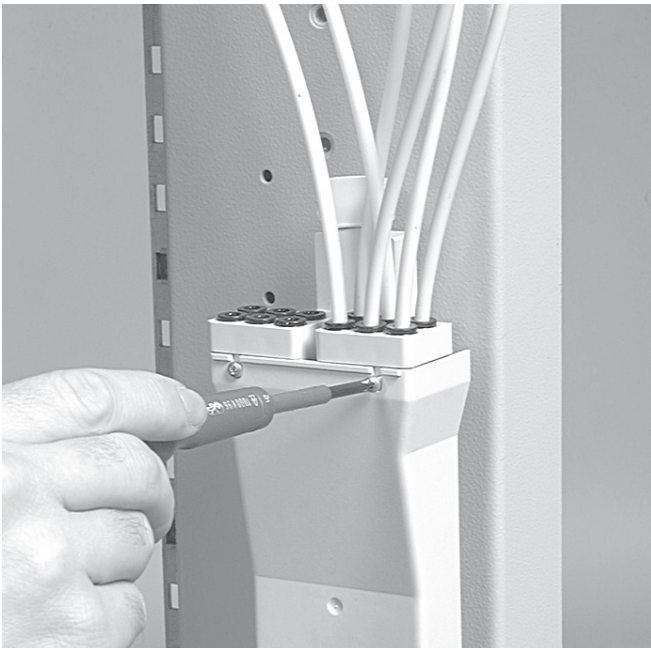

4.1.31 Slide the cover over the break-out and secure with the screws.

#### c) IFC cable



4.1.32 Kit content FIST-ITK2

- 1 pc IFC-bracket
- 2 pcs bolts & nuts
- Tie-wraps
- 1 pc Velcro wrap
- 1 pc adhesive foam tape

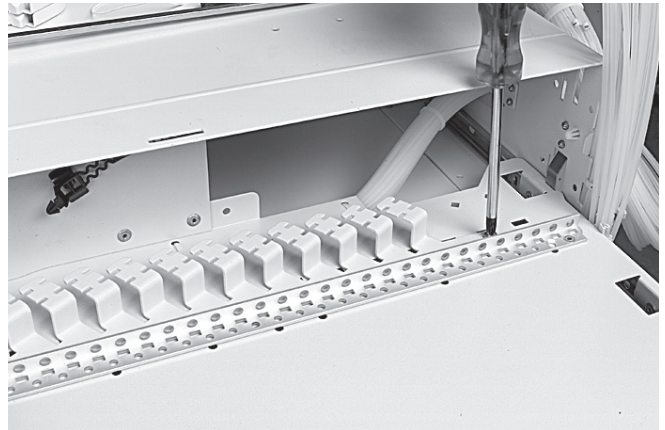

4.1.33 Mount the bracket onto the shelf using the bolts & nuts.



4.1.34 Remove the cable jacket over approximately 1.7 m.



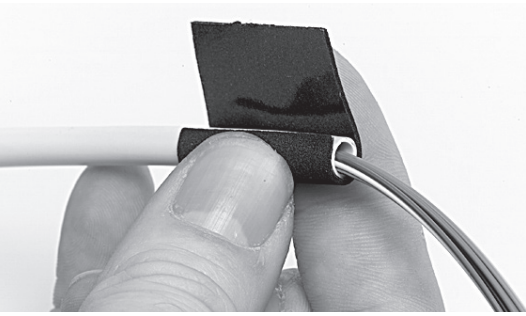

4.1.35 Apply one layer of foam tape around the IF-cable, at the end of the jacket. This tape prevents easy pull-out of the cable.

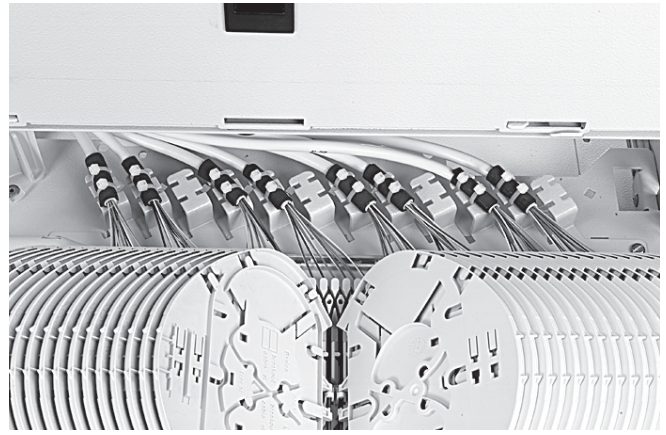

4.1.39 In case of single circuit tray (SC): 2 fibers can be terminated. The following positions should be used on the metal bracket: 1, 2, 4, 5, 7, 8, 10, 11.

In case of single circuit (SC trays) with 4 semi-tight fibers per tray, use all the bracket positions and remove the secondary coating in the middle of the groove plate. Do not use (= leave empty) trays number 4, 8, 12, 16.

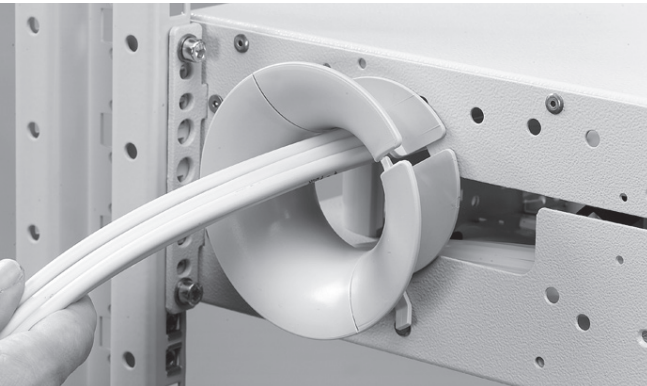

4.1.36 Feed the IFC through the horn.

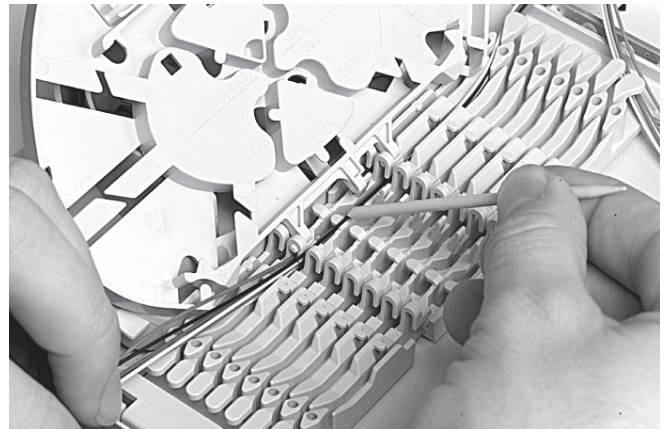

4.1.40 Make sure the transition of secondary to primary coating is in the splice protector. If this is not possible: strip the secondary coating (semi-tight) in the middle of the groove plate.



4.1.37 Fasten the cable onto the bracket with the tie-wraps. Don't squeeze the cable !!! For ease of installation start at the left.

## 4.2 Side cable termination directly on the shelf

### a) Loose tube cable

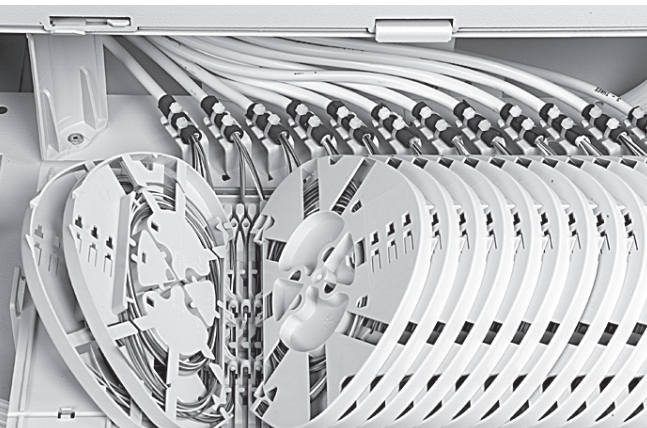

4.1.38 In case of Single Element cassettes (SE): 6 fibers can be terminated per tray.



4.2.1 Right side mounting cable coming from the bottom.



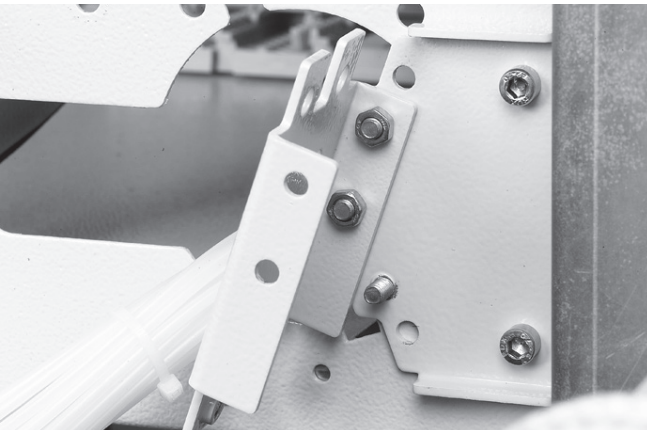

4.2.2 Right side mounting cable coming from the top.

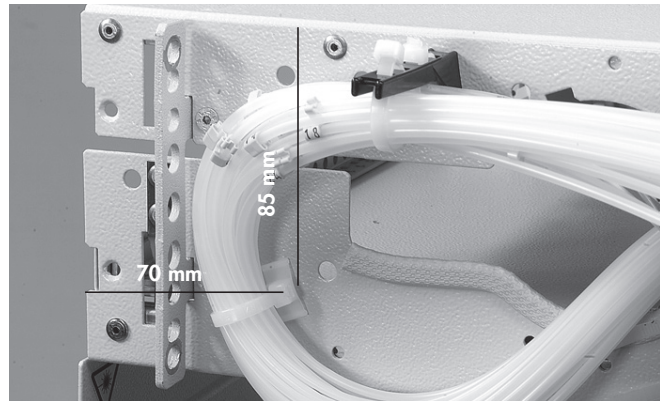

4.2.5 In case of front mounting, mount the fixed tie wrap as shown.

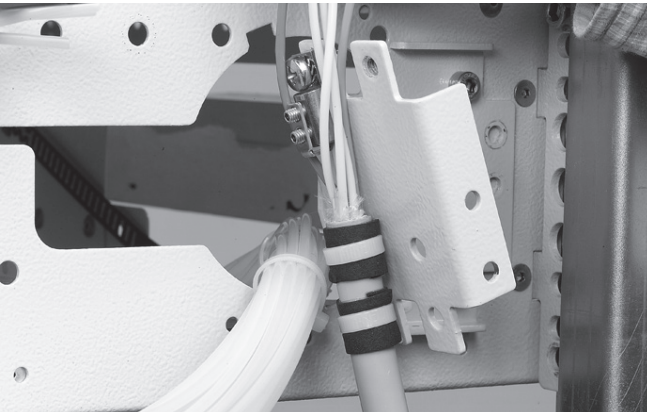

4.2.3 Strip the cable over 3,5 m. Cut the strength member at 35 mm from the outer jacket. Apply foam tape at the tie wrap positions. Install the prepared cable on the side termination plate.

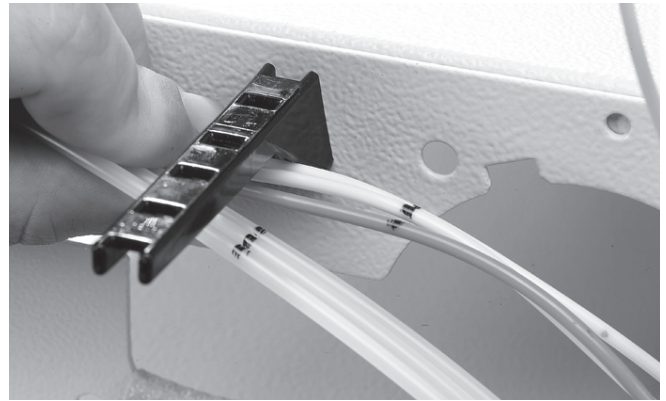

4.2.6 Mark the transportation tubes 10 mm from the plastic stand-off. Mark the loose tubes 30 mm from the plastic stand-off.

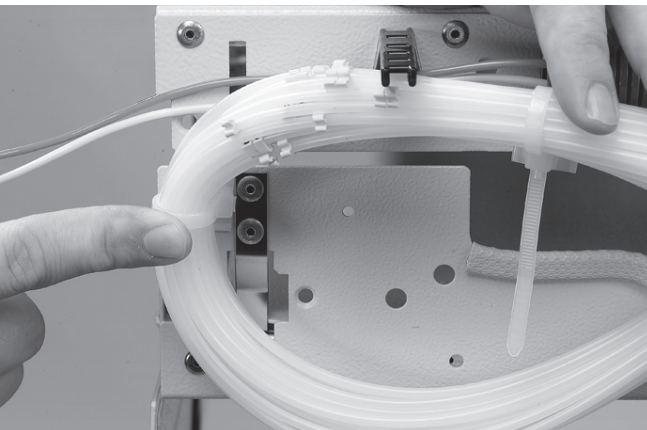

4.2.4 Install the plastic stand-off as shown. Mount the fixed tie wrap at the position as shown.

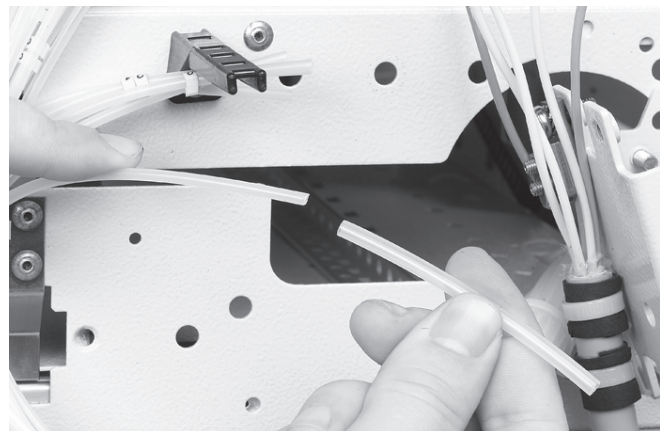

4.2.7 After stripping the loose tubes and cutting of the overlength of the transportation tubes, slide the FOPT-CT over the transportation tubes. Clean the fibers very well to make feeding easier.

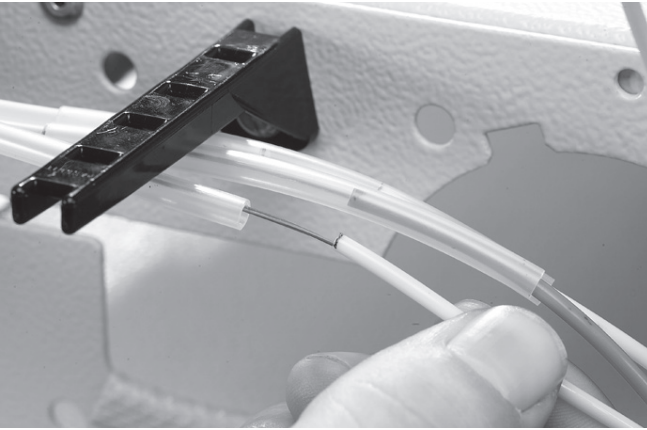

4.2.8 The FOPT-CT should overlap loose tube and transportation tube.

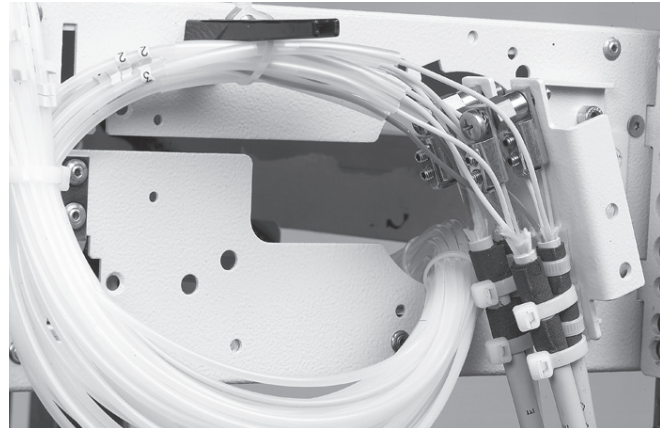

4.2.10 In case of max. 4 cables, use the FIST-UST-EXKIT-2CA for the next 2 cables.

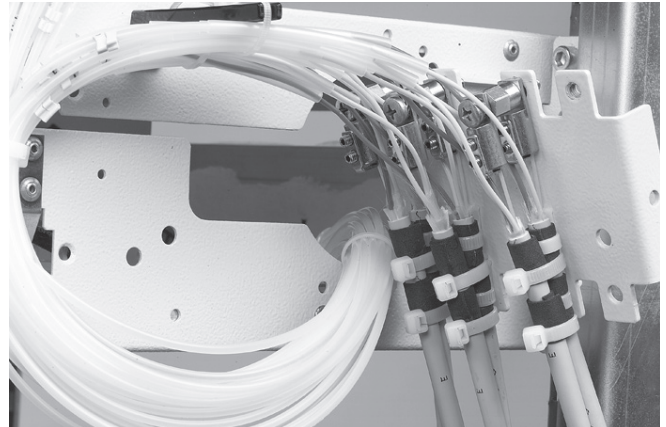
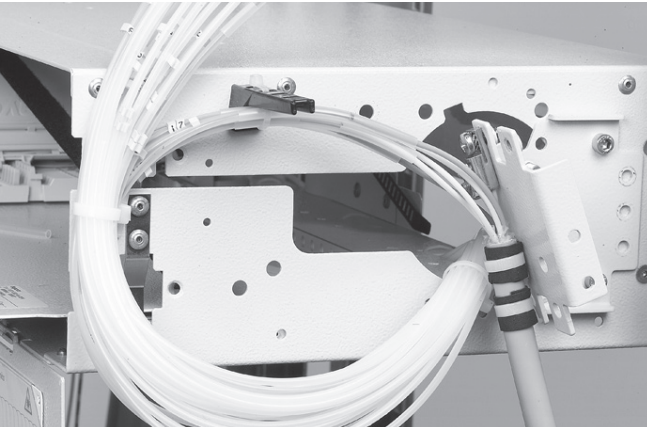

4.2.11 An extra plate can be used with a limitation of 2 cables on top of each other (positions as shown). Order FIST-UST-EXPL.

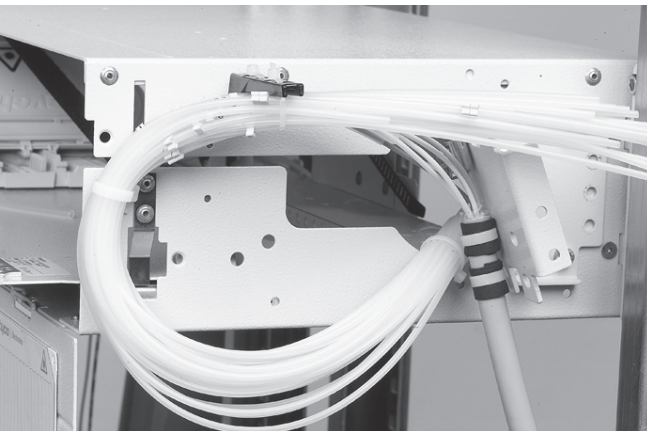

4.2.9 Transportation tubes can be fixed on the plastic stand-off with tie wraps.

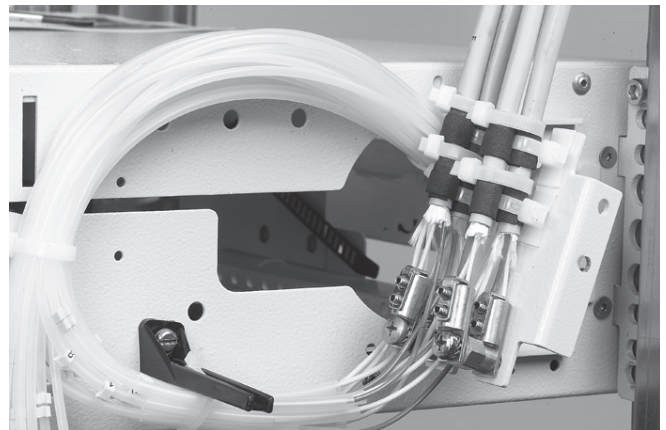

4.2.12 In case the cable is coming from the top.



**b) Modular cable**

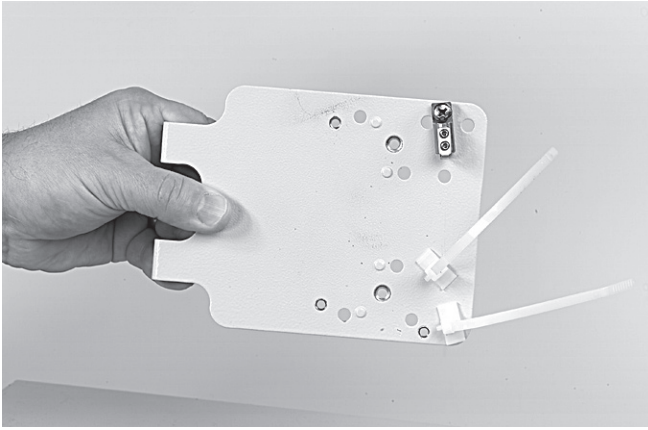

4.2.13 Assemble the releasable tie wraps and the strength member connectors onto the side termination plate as shown in the picture.

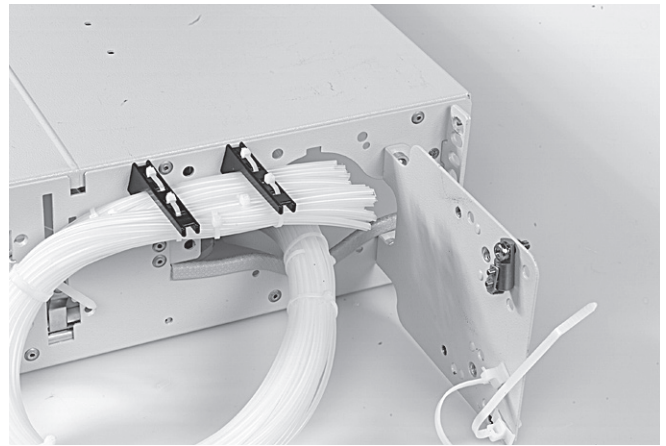

4.2.16 Secure the transportation tubes on the stand off brackets in two bundles as shown in the picture.



4.2.14 Install the side termination bracket on the shelf, before mounting the shelf in the rack.

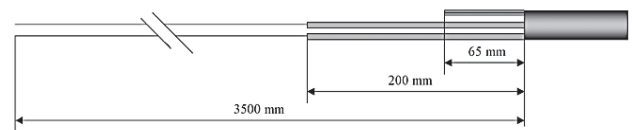

4.2.17 Remove the outer cable jacket over a distance of 3500 mm starting from the side term plate and cut the strength member at 65 mm from the cable jacket.

4.2.18 It is recommended to install the blocking between the 10 mm micro-duct and micro-cable at the bottom of the rack.

4.2.19 Remove the micro tube up to 200 mm from the cable jacket and clean the fibers.

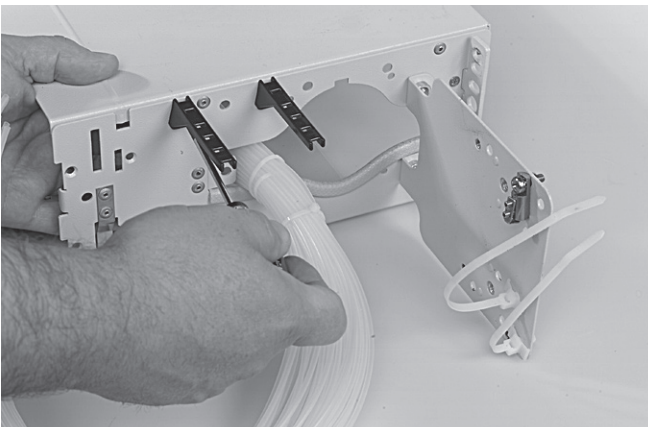

4.2.15 Install the two stand off brackets in the first and the third hole from the front of the shelf.

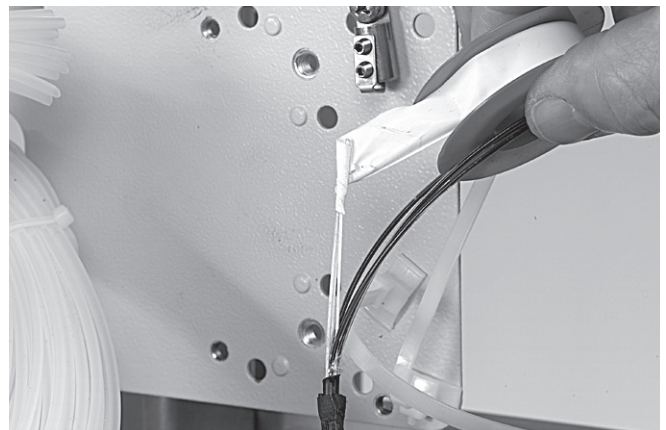

4.2.20 Wrap some layers of teflon tape around the ends of the strength members to keep them together.

Note: to avoid crossings of the loose buffer tubes and the strength members, 2 strength members can be cut if necessary.

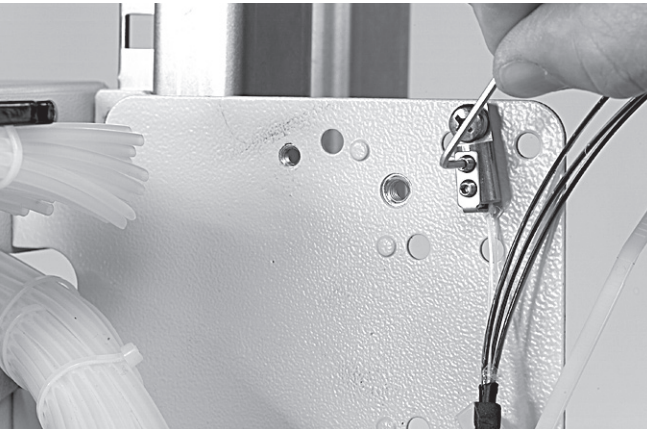

4.2.21 Insert the strength member into the strength member connector and tighten the screw.

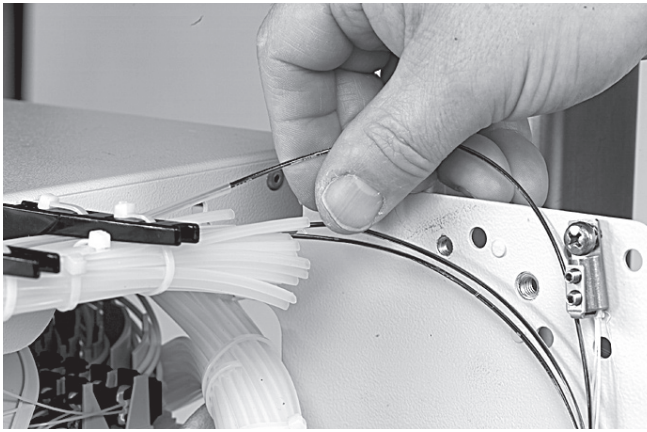

4.2.22 Insert the fibers and loose tube(s) into the FOPT-CS.

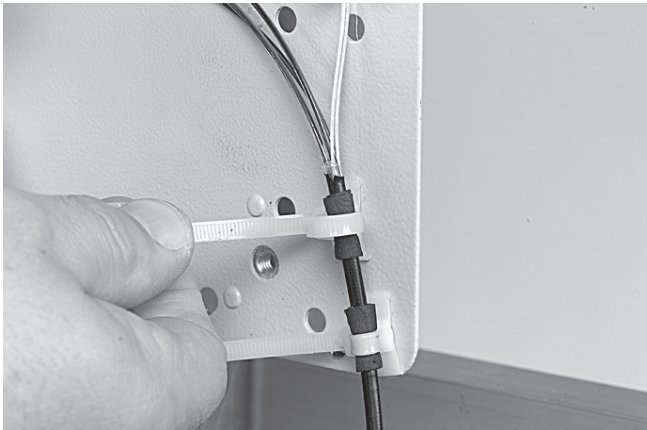

4.2.23 Apply foam tape at the tie wrap positions. Install the prepared cable(s) on the side termination plate.

### 4.3 Cable entrance at the back of the shelf

#### a) Loose tube cable

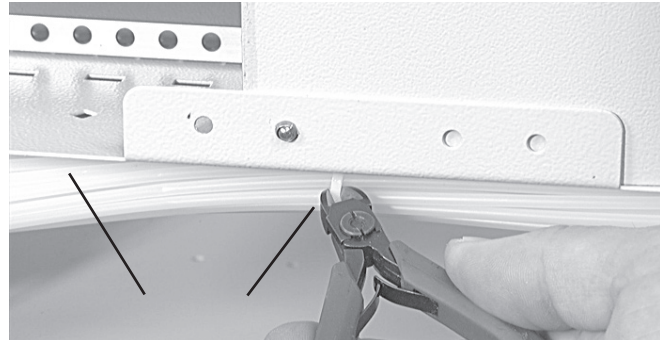

4.3.1 In case of 19" and ETSI, remove two tie-wraps at the bottom of the tray. Do not remove tie-wraps in case of 15".

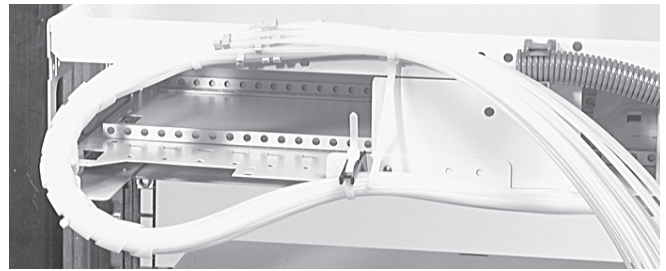

4.3.2 In case of strength member termination in the rack (use FIST-GSS2-CT-BR-2): mount the flex tube holder and the plastic stand-off in case of 19" and ETSI. In case of 15" there is no stand-off needed. Mount the tubes to the black stand-off with a tie wrap. Protect the tubes with the spiral tubing and make sure the bend is smooth. Terminate as shown (for details see similar side termination).

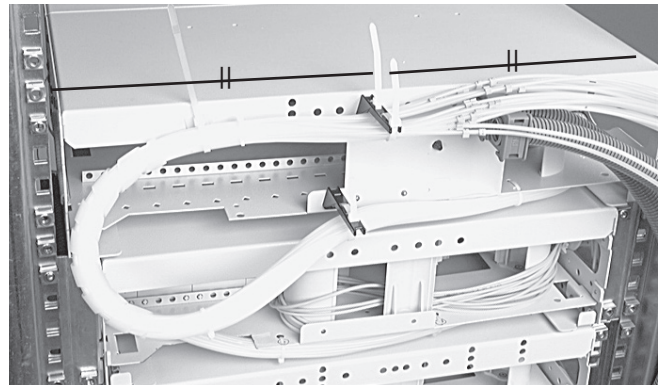

4.3.3 In case of a second cable, replace the releasable tie wrap by a stand-off.



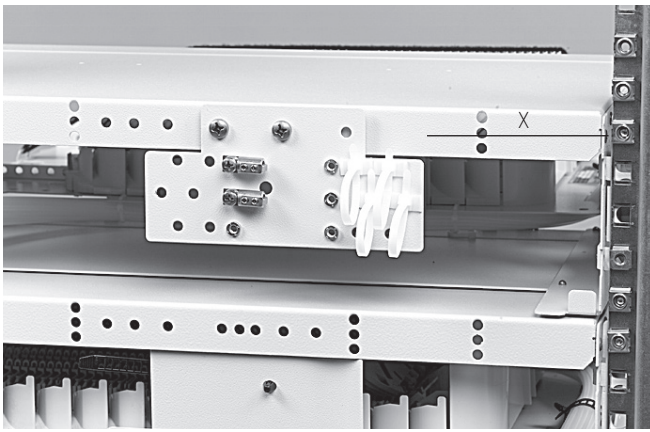

4.3.4 In case of strength member termination on the shelf (use FIST-GSS2-CT-BS-2): mount the cable plate, the strength member connectors, the black stand-off and the tie-wraps as shown in 4.3.6. Use the plastic spacers between plate and shelf. The distance between the plate and the right side of the shelf X is 8 cm for a 19" shelf and 10,5 cm for an ETSI shelf and 2 cm for 15" shelf.

4.3.5 Remove 3.5 m cable jacket. Leave 55 mm of the strength member.

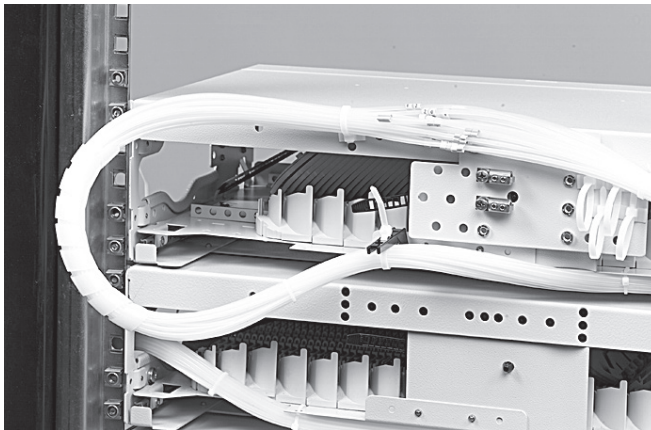

4.3.6 Mount the transportation tubes as shown. Protect the tubes with a 200 mm spiral tubing and make sure the bend is smooth.

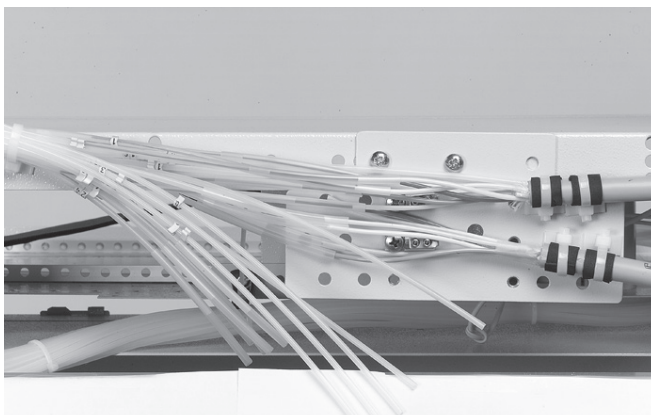

4.3.7 Install the cables. Strip the loose tube at 50 mm from the cable jacket end. Cut the transportation tube at 60 mm from the cable jacket end. Slide a 75 mm long FOPT-CT over the transition. If the loose tube diameter < 2,3 mm the use of the FOPT-CT is not needed. (In this case don't cut the transportation tubes too short).

## 5 Termination of the pigtail

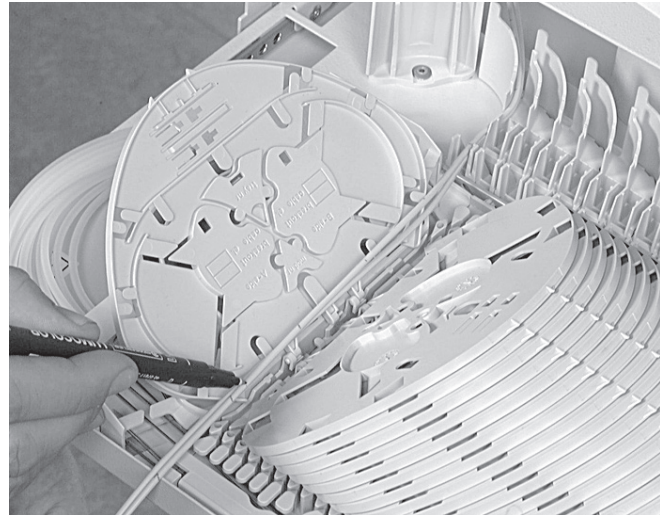

5.1 Route the pigtails without leaving any slack through the trumpet, through the KTU bracket to the correct tray. Mark in the middle or at the end of the tray to have some slack for sliding the tray.

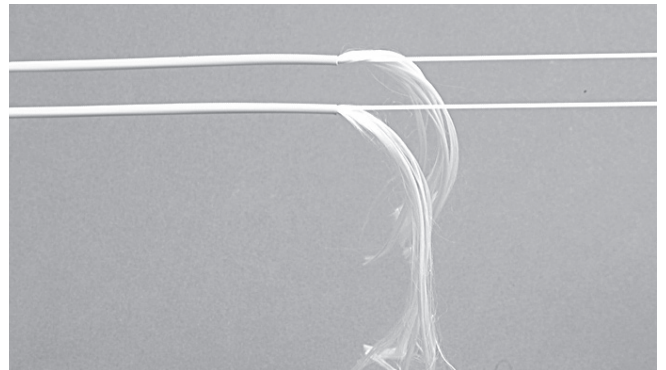

5.2 Remove the jacket beyond the marking point. Cut away the Kevlar leaving 50-100 mm from the edge of the jacket. Cut the pigtails leaving  $\pm 1.7$  m length after the marking point.

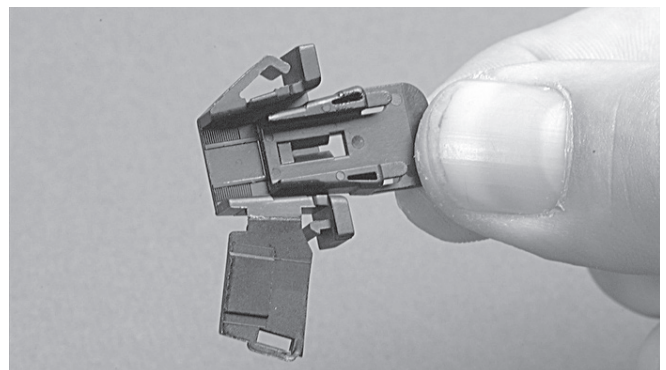

5.3 Mount the 2 pieces of the KTU as shown.

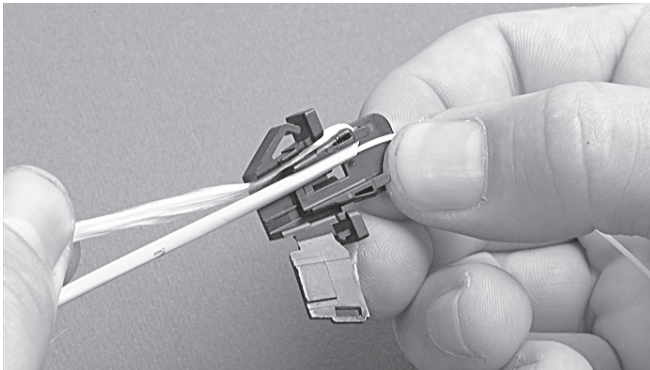
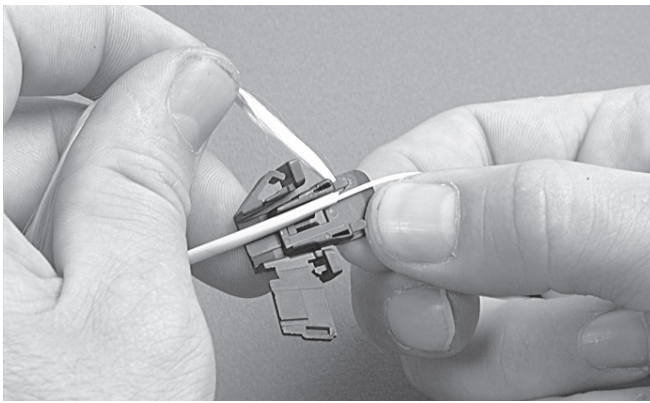

5.4 Guide the prepared pigtail in the KTU. Make sure the kevlar yarns do not entangle the fibers.

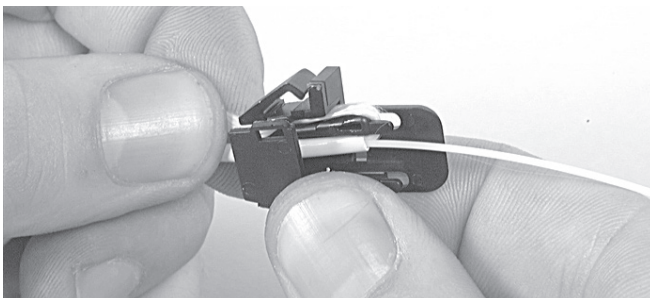

5.5 Close the KTU.

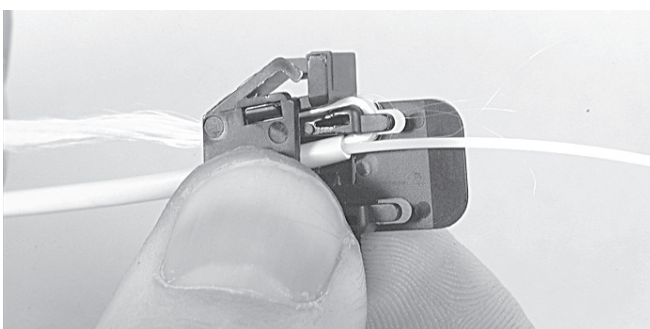

5.6 Slide the inner part to the left as much as possible by pulling the jacket and kevlar at the same time. Cut the excess kevlar leaving 5-10 mm.

**In case of 2 pigtails**

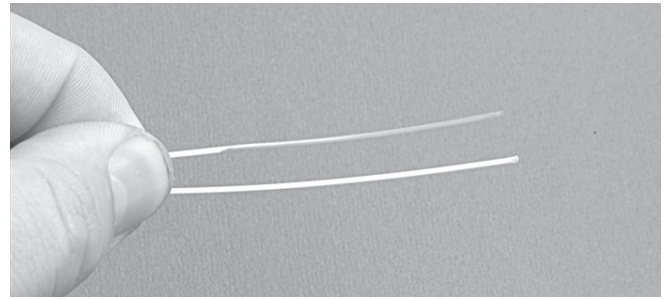

5.7 In case of 2 pigtails/KTU; identify 1 of the fibers with a marking pen.

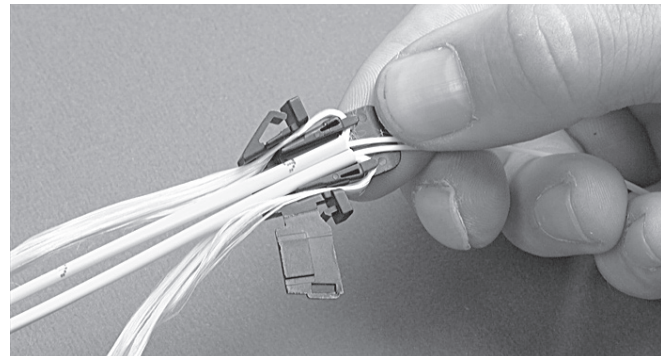

5.8 Guide the prepared pigtails in the KTU. Make sure the kevlar yarns do not entangle the fibers. Keep the kevlar from each pigtail separated.

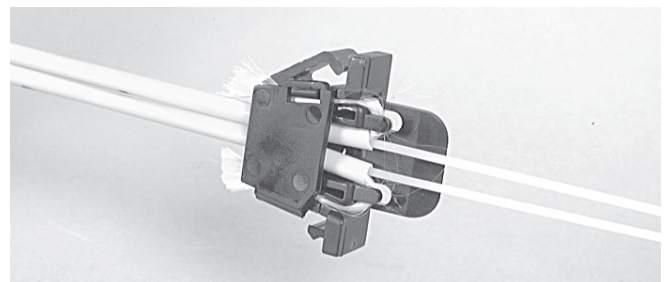

5.9 Slide the inner part to the left as much as possible by pulling the jacket and kevlar at the same time. Cut the excess kevlar leaving 5-10 mm.

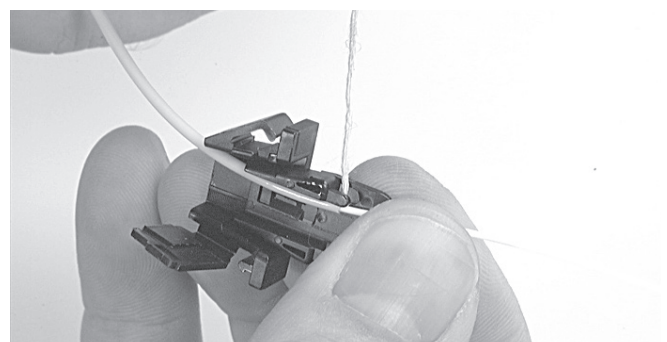

5.10 In case of less kevlar (typically this means pigtail diameter < 2,3 mm); wrap the kevlar to ensure a good strain relief.



**In case of 4 pigtails**

Diameter of the pigtails maximum 1.8 mm

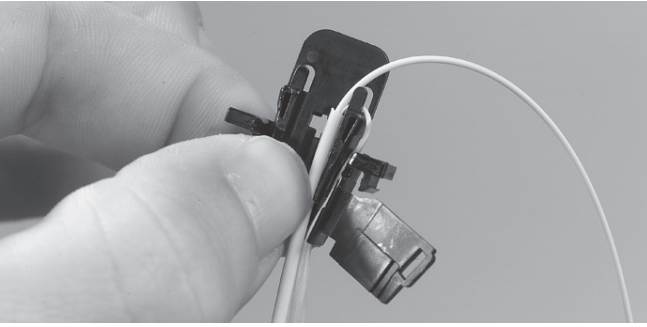

5.11 Installation of first and second pigtail at the same side of the KTU.

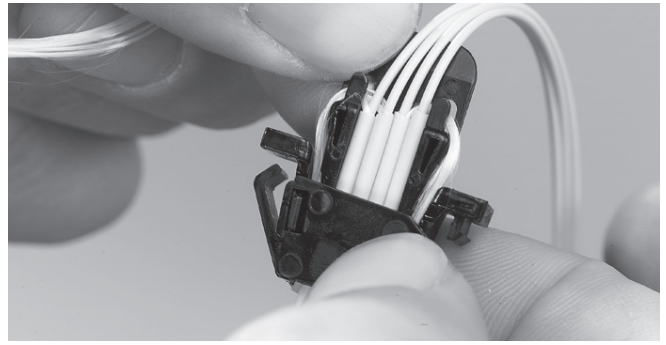
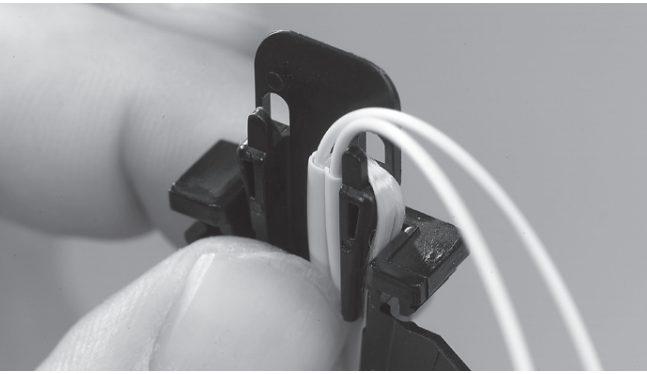

5.13 Close the KTU.

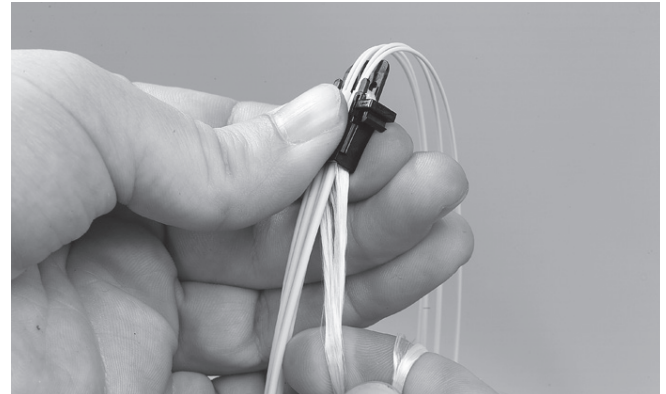

5.14 Pull the jacket and Kevlar at the same time to slide the inner part of the KTU into the outer part.

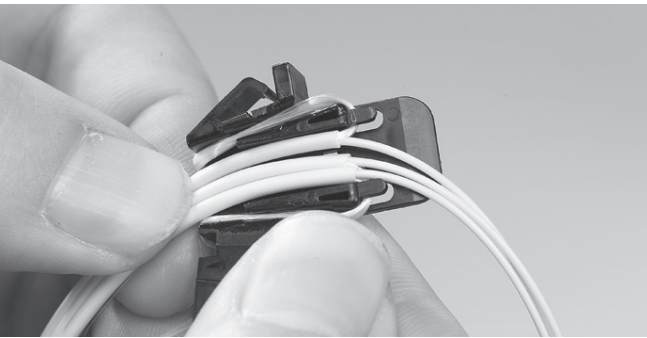

5.12 Installation of third and fourth pigtail at the opposite side of the KTU.

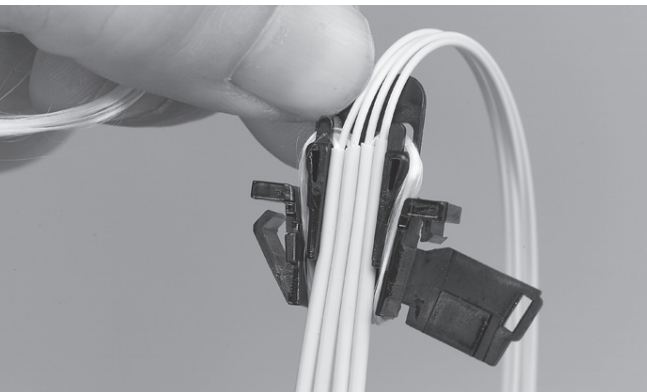

5.15 Cut the excess of the Kevlar, leaving 5-10 mm.



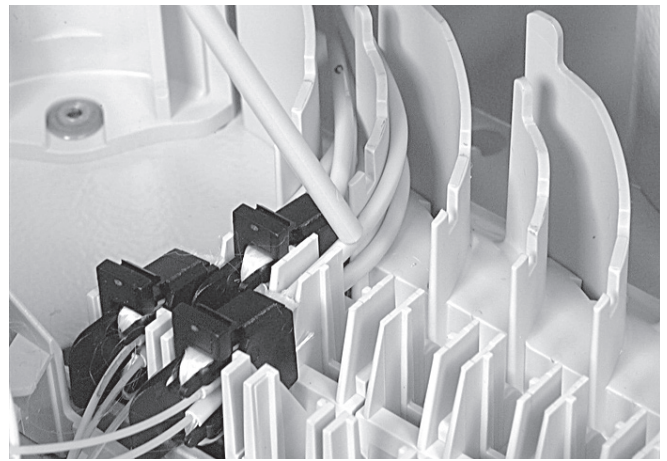
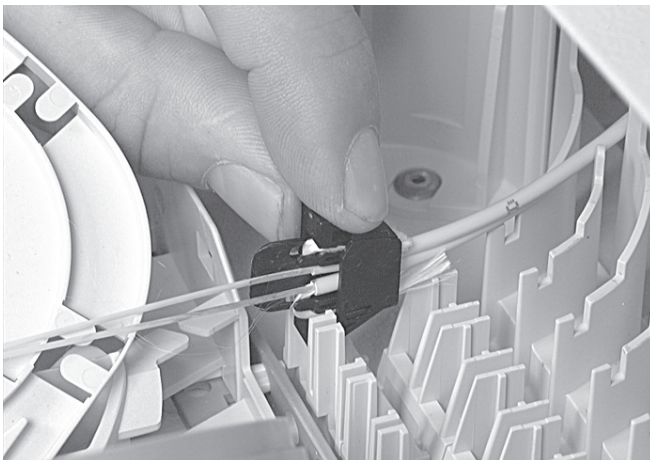

5.17 If the pigtail diameter > 2.6 mm, use the fiber guiding pin to push the pigtail into the pigtail slot.

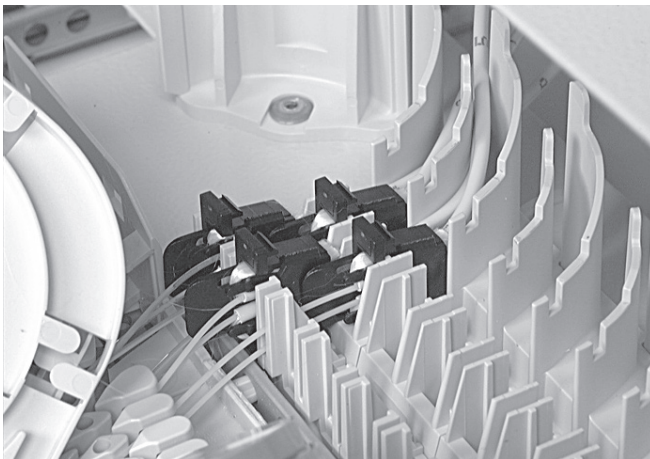
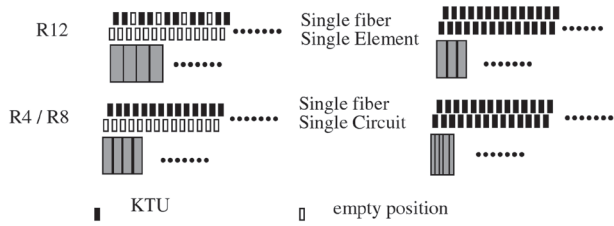

5.16 Slide the KTU in the correct slot. Respect correct orientation of the KTU. The front lip should be positioned left in top view. The position of the KTU's is indicated on the drawing (application cable to pigtail is indicated).



5.18 Guide the fibers into the corresponding groove. Make sure all fibers are positioned under the lips.



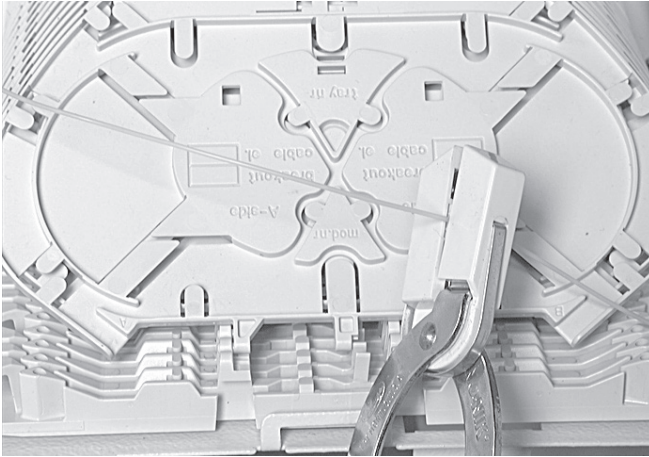
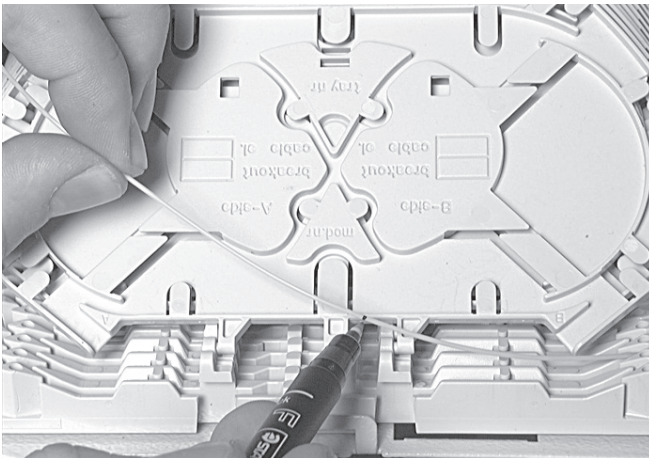

5.19 Make sure the transition of secondary to primary coating is in the splice protector. If this is not possible: strip the secondary coating (semi-tight) in the middle of the groove plate.

## 6 Splicing + storage

### 6.1 General

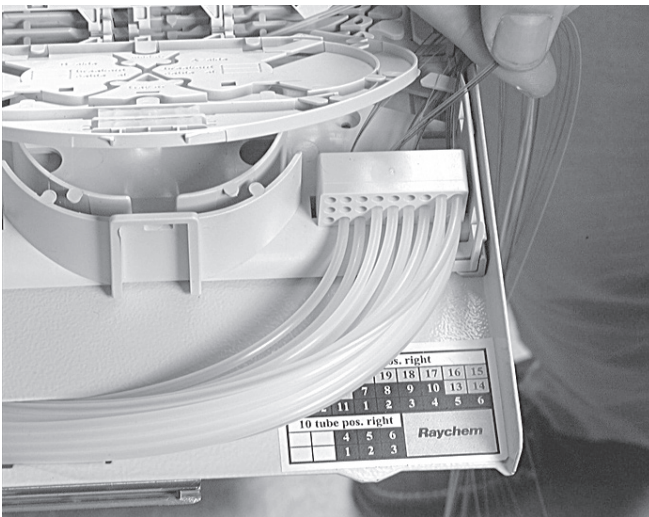

6.1.1 Select the correct fibers from the cable side according to the tube position labeling and the color code.

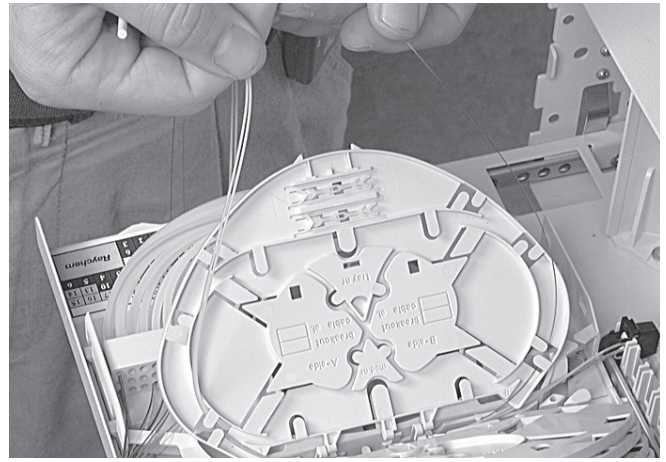

6.1.2 Guide the fibers in the groove plate. Make sure all fibers are positioned under the lips. Splice the fibers and protect the splice. Position the splice in the spliceholder.

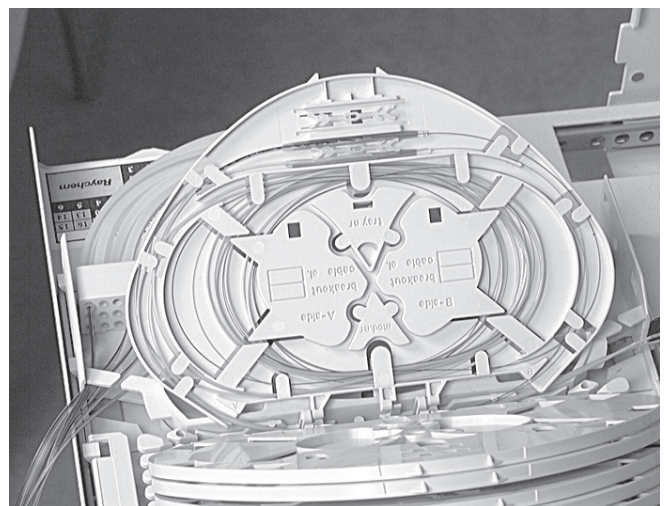

6.1.3 Store the fibers into the tray. Follow the exact routing as shown. Try to minimize the number of coils.





6.1.4 If both fibers are coming from the same side, follow the routing as shown.

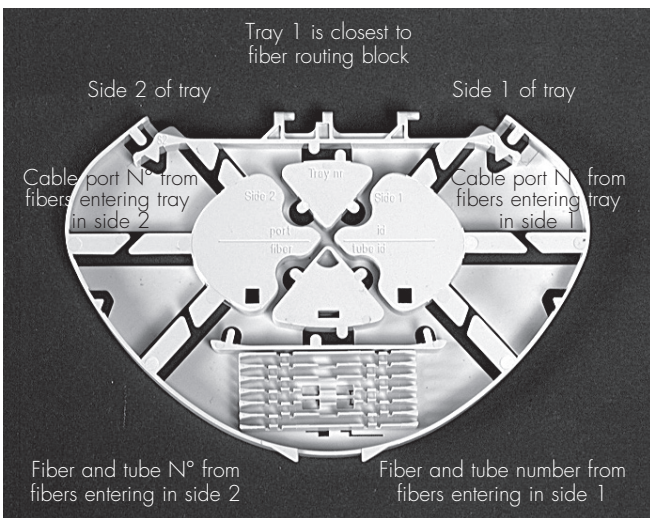

6.1.5 Use a permanent marker to write splicing information on the tray.

## 6.2 Ribbon

6.2.1 In case of ribbon pigtail: limit the numbers of torsion in the organizer system to avoid optical losses.

## 7 Closing the shelf

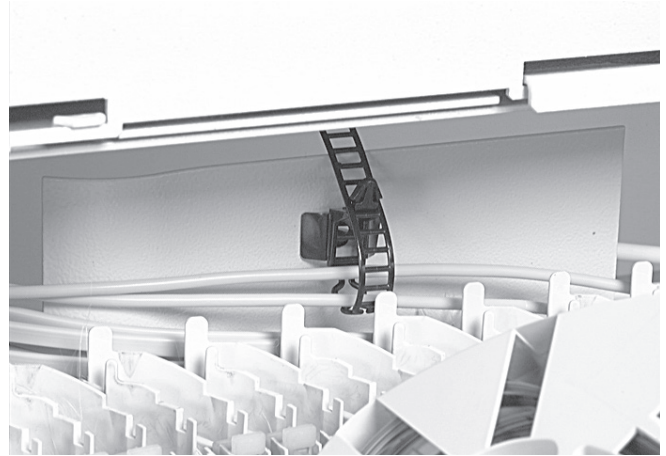
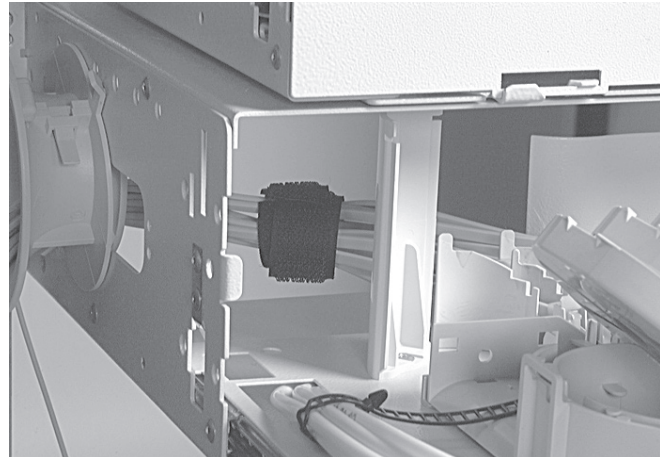

7.1 After installation, bundle the pigtails with a piece of Velcro. In case pigtails protrude above the KTU brackets the black tie wrap can be used.

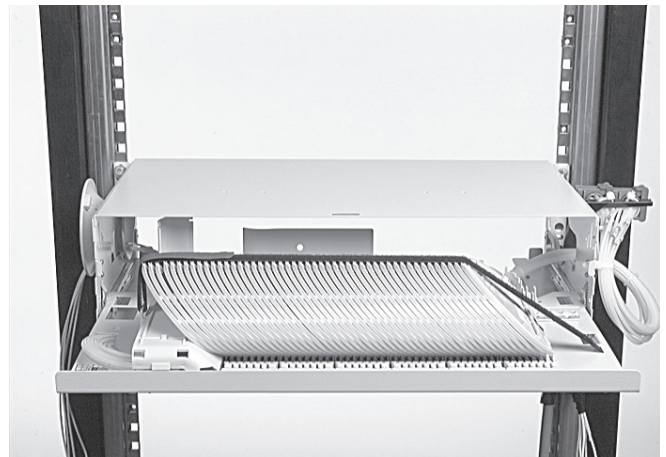

7.2 Put the cap over the fasblock. Click a tray lid onto the last tray. Lock the trays with the Velcro.



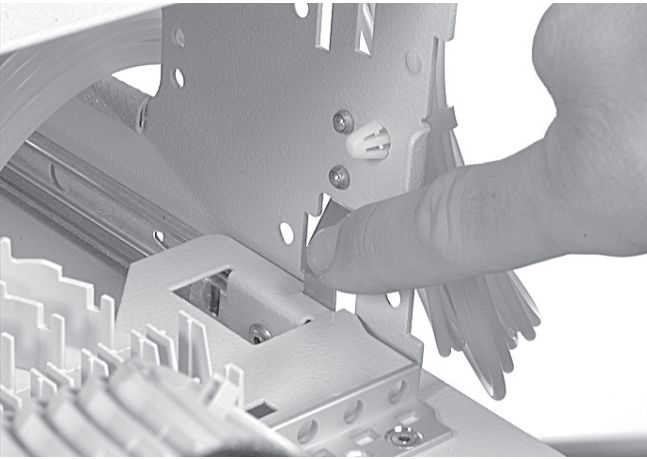

7.3 Close the drawer by activating the spring on the right side of the unit.

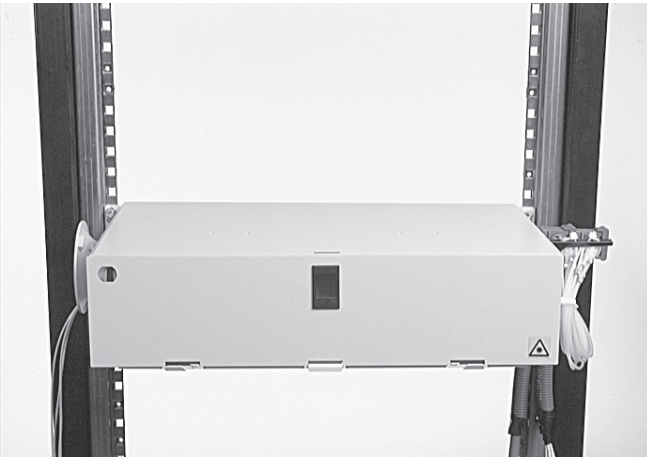

7.4 Close the cover.

## 8 Important steps

- Clean the fibers very well to make feeding easier.
- Always respect 30mm bendradius and prevent kinking when repositioning tie-wraps for the transportation tubes.
- Respect overlap dimensions for transition loose tube-transportation tube.
- Strip the loose tubes at 3,5 m.
- Provide sufficient pigtail slack for easy sliding of trays.
- For each tray select correct groove and KTU position.
- Use correct orientation and position of the KTU in the KTU bracket.
- Prevent twisting of the ribbon fiber.
- Coil the fibers at a maximum diameter, minimize the number of coils.
- Make sure all fibers are positioned under the containment lips.

---

To find out more about CommScope® products, visit us on the web at [www.commscope.com](http://www.commscope.com)

For technical assistance, customer service, or to report any missing/damaged parts, visit us at:  
<http://www.commscope.com/SupportCenter>

© 2017 CommScope, Inc. All rights reserved.

All trademarks identified by ® or ™ are registered trademarks or trademarks, respectively, of CommScope, Inc.

This document is for planning purposes only and is not intended to modify or supplement any specifications or warranties relating to CommScope products or services.

This product is covered by one or more U.S. patents or their foreign equivalents. For patents, see:  
[www.commscope.com/ProductPatent/ProductPatent.aspx](http://www.commscope.com/ProductPatent/ProductPatent.aspx).