

TC-957-IP
 Rev A, Feb 2017
 www.commscope.com

Building distributor

Introduction

The Budi is a building distributor for a fiber management system that offers the functions of splicing. Provides a mechanical and environmental protection for the fiber optic components.

Kit content

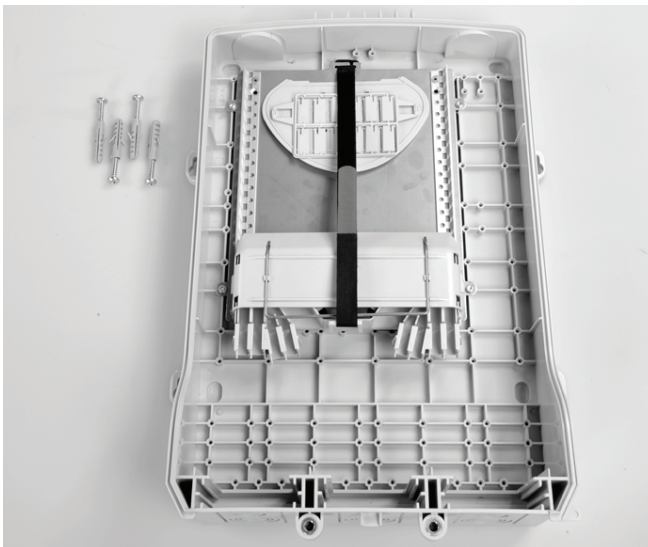

- Box

Accessories

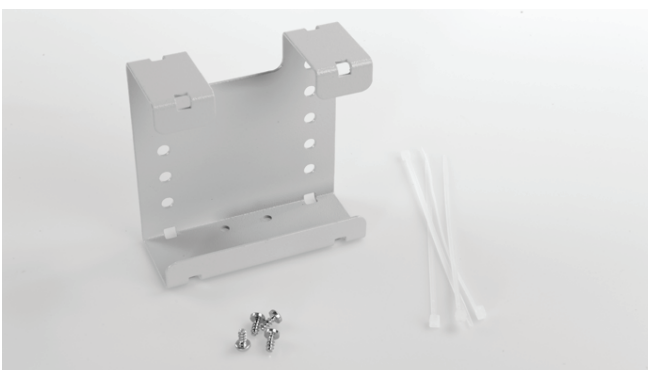

- Loop bracket
 Loop of 8 loose tubes (ø 2.4 mm).
 Maximum window of 2.6 m.

Seals

Wrap around cable seals

Sealblock 4 x 10 mm

Cable diameter (mm)	Foam (± 5 mm)
3	95
4	90
5	80
6	75
7	70
8	60
9	50
10	40

Sealblock 4 x 15 mm

Cable diameter (mm)	Foam (± 5 mm)
9	125
10	115
11	105
12	95
13	85
14	70
15	60

Sealblock 2 x 20 mm

Cable diameter (mm)	Foam (± 5 mm)
14	155
15	140
16	125
17	110
18	95
19	85
20	75

Sealblock 24 x 7 mm

Cable range 1.8 – 7 mm

Inline seal 1 x 18

To use in ports S4-S5 only
 Cable range 3 – 18 mm

Standard seals

PG 16
 PG 21
 PG 29
 PG 29 (PTS 24)

1 Preparation of the box

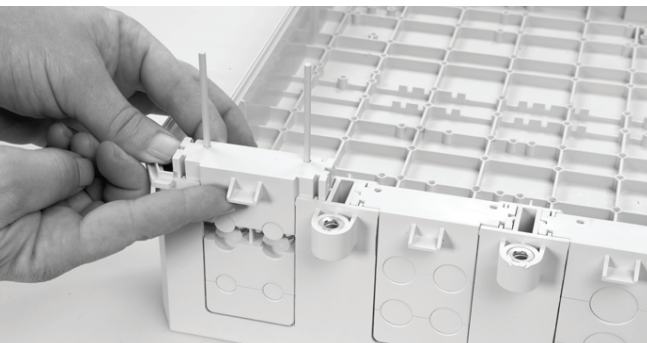
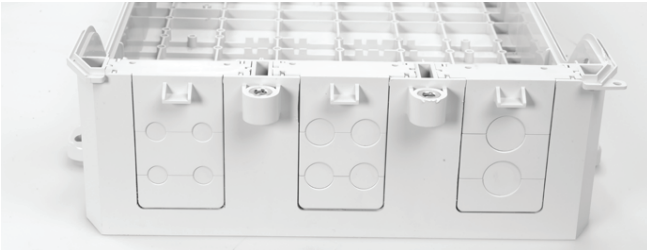
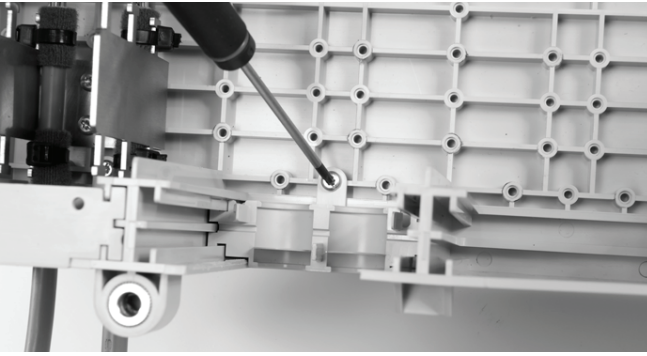

1.1 Different wrap-around ports are available (including brackets). Use two guiding pins to open the ports and to secure the bottom part to the box. Cut out the plastic part if you want to install a cable.

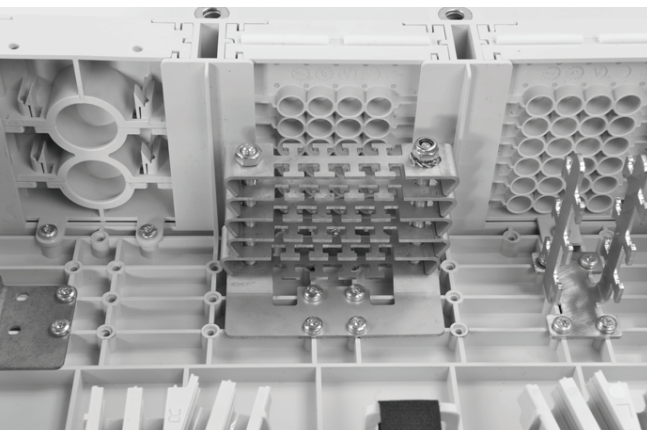

1.2 Install the cable bracket depending the cable seal.

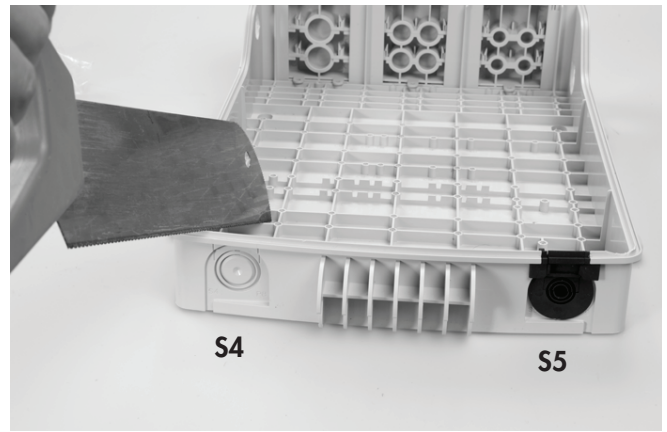

1.3 Use a hacksaw to reach the onion rings, which can be opened with a plier to open the in-line ports (S4/S5).

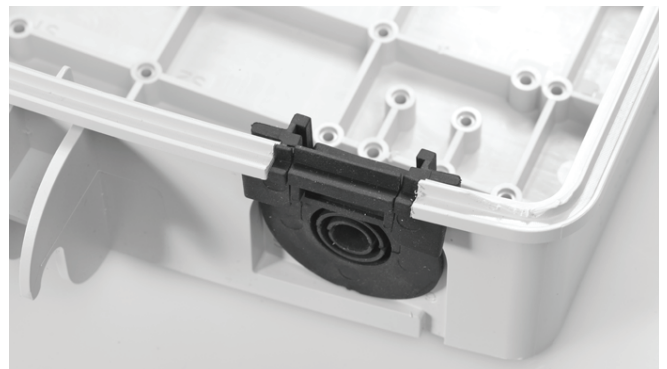

1.4 Install the wrap-around rubber seal into the port.

2 Looped cable

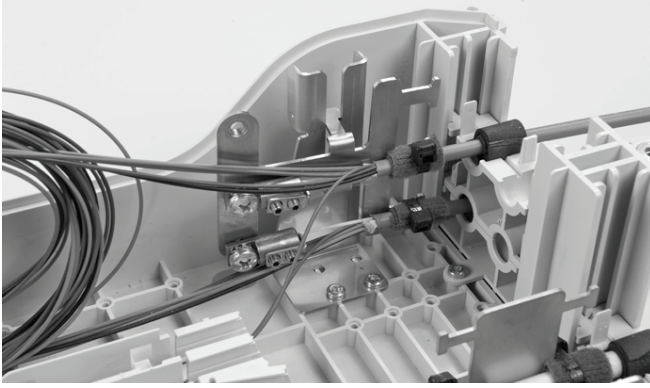

2.1 Install the looped cable into the ports.

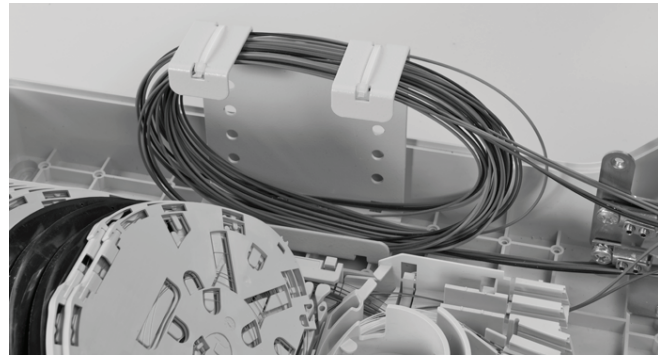

2.2 Store the looped tubes into the loop bracket.

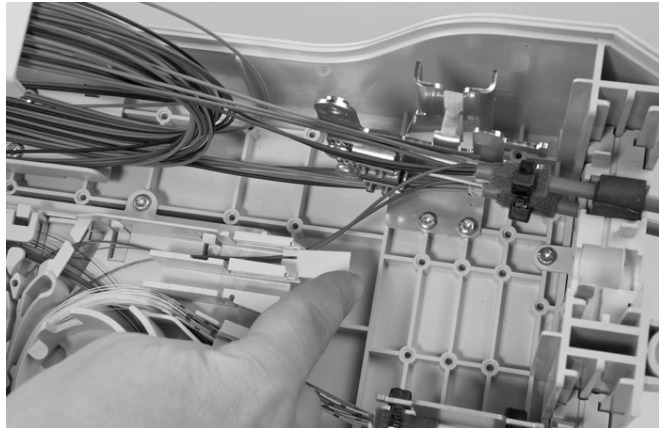
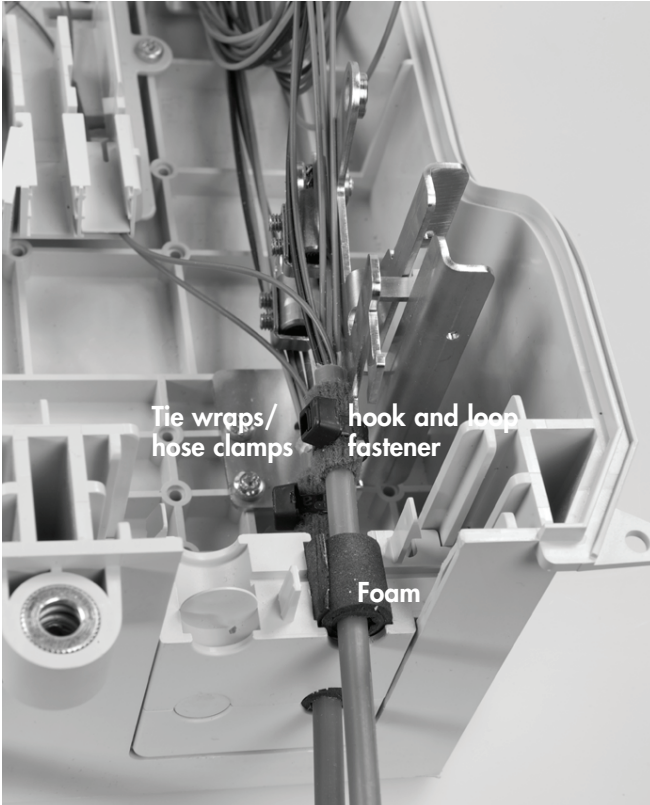

2.3 Route the loose tube towards the FAS block.

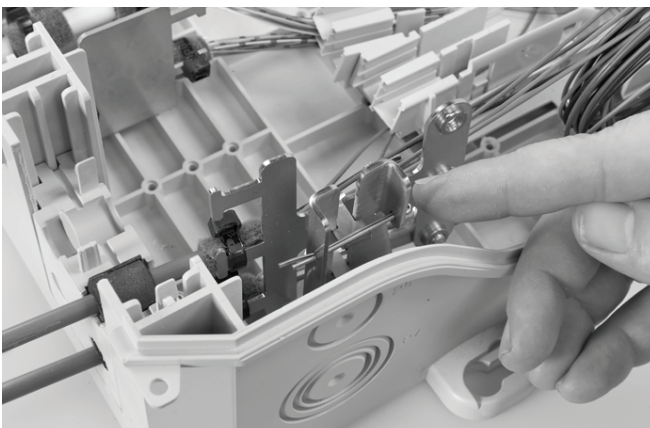

3 Drop cables

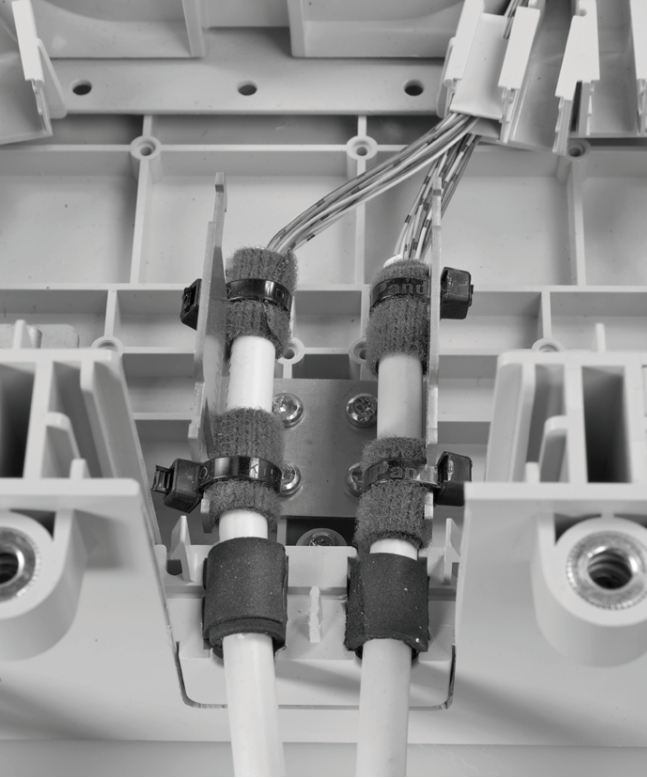

3.1 Install the drop cables into the ports.

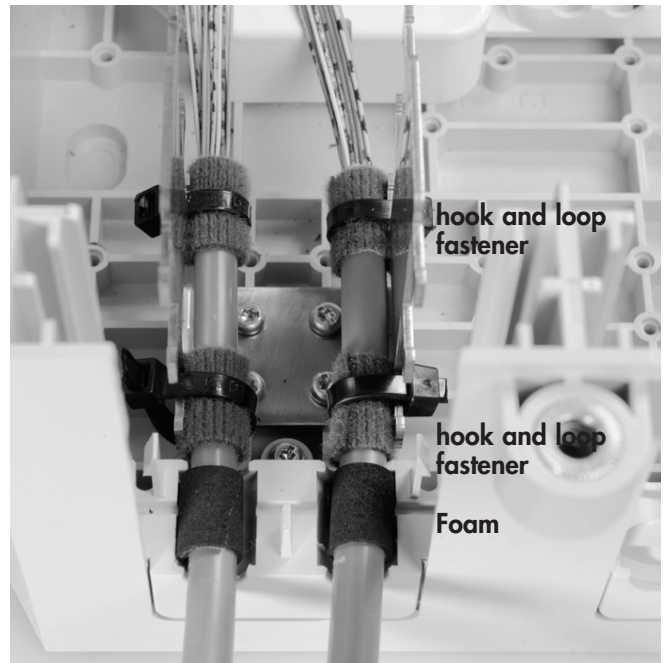
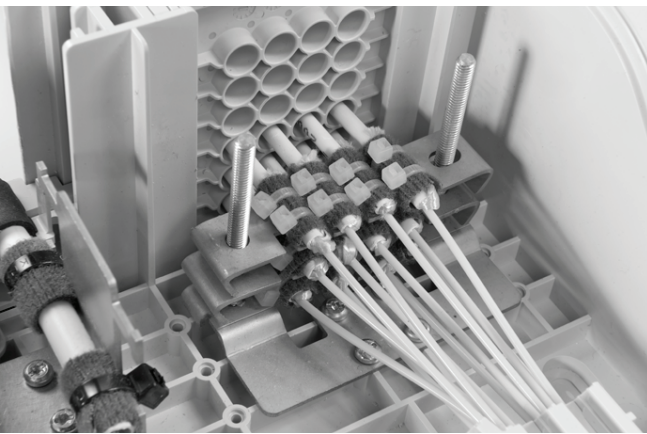

3.2 Install the cable into the port and secure with hook and loop fastener tape onto the bracket and seal with foam (see length page 1).

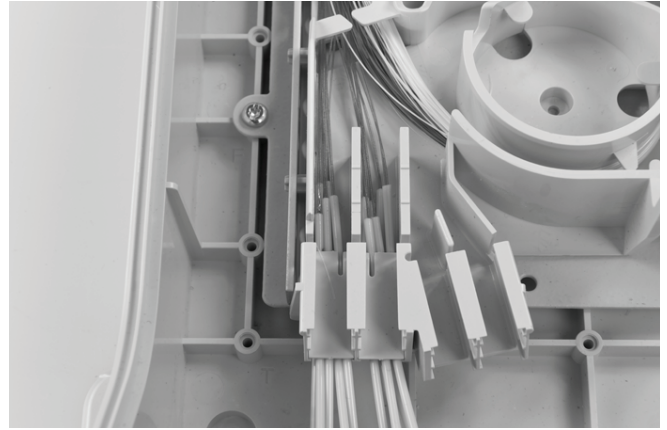

3.3 Route the fibers or tubes towards the FAS block.

4 Fiber routing

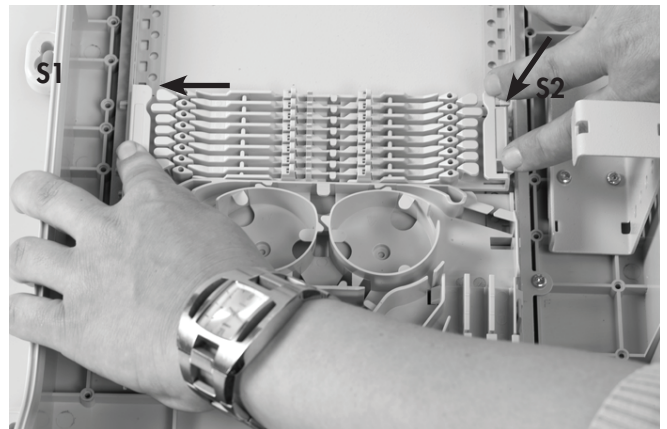

4.1 Secure the wraparound groove plate on the UMS by putting the plate with the long protrusions in the S1 UMS-profile and sliding the plate in the S2 UMS-profile until it snaps. (Do not leave gaps between groove plates).

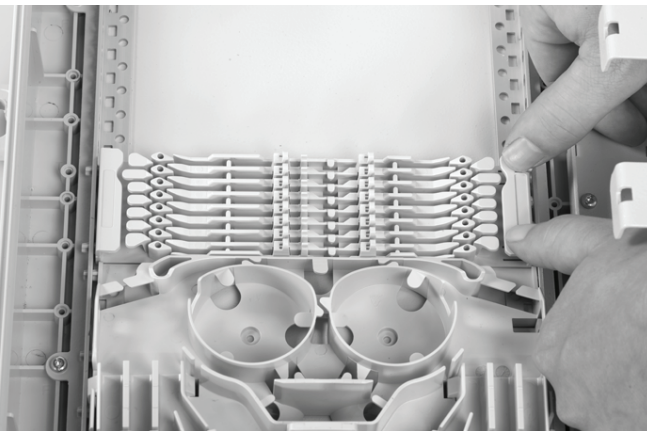

4.2 To remove push the two snapfits at S2 UMS-profile and slide the wraparound plate towards S1 UMS-profile.

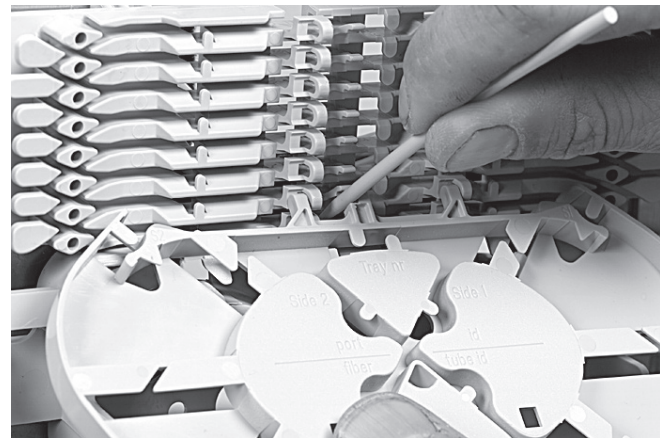

4.4 To remove the tray put the fiber guiding pin between lip on wraparound groove plate and tray and move lateral towards S1.

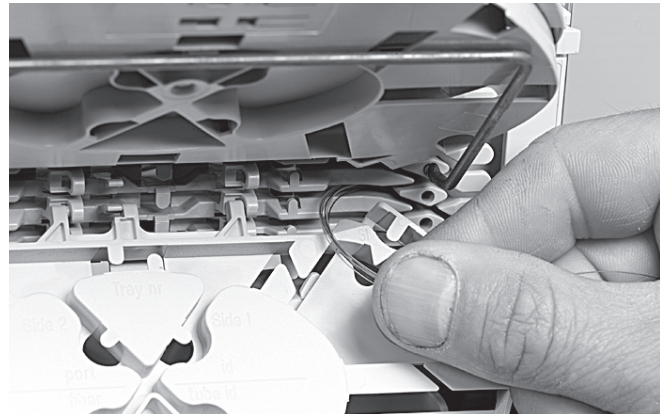

4.5 Position the wedge carefully such that the groove is still accessible for the fibers and be careful not to push the wedge against fibers. To remove the wedge, use two hands to pull on both ends (near the groove plate). Route the fiber in the grooves of the wraparound groove plates to the entrance of the identified tray. Fiber must be routed in the groove below the hinge of the tray!



4.3 Place a tray in the wraparound groove plate; do this by pushing the lip on the groove plate (lowest possible position) slightly down with the tray and move the tray lateral into the hinge-cavities of the groove plate. To snap the High Capacity Single Element tray (HCSE) in the W/a single fiber groove plate **leave always one hinge facility open between Fasblock or previous tray and the HCSE-tray.**

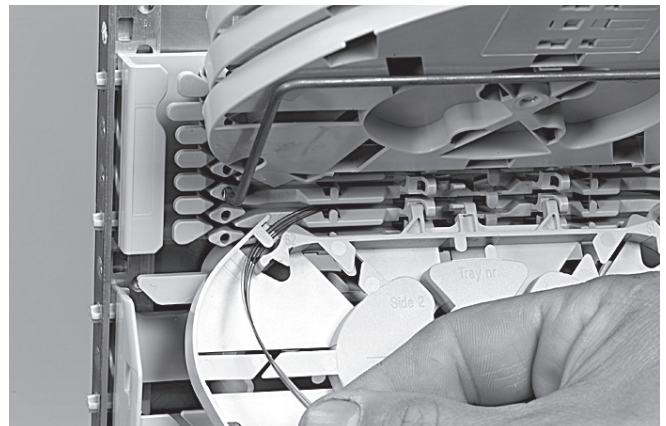

4.6 Pull gently on the fibers in the tray and make sure that the fibers are well contained in the routing block and wraparound groove plate.

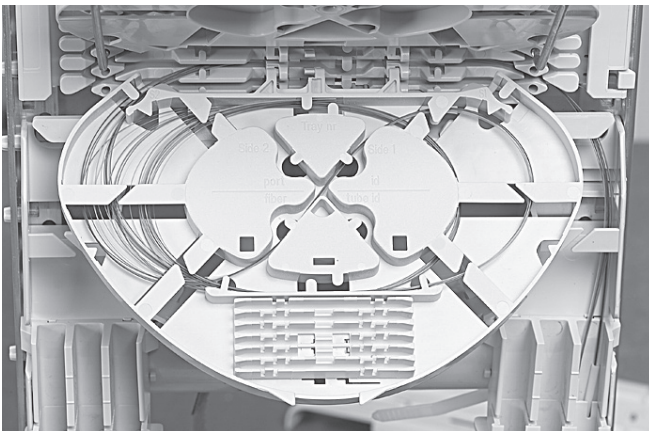

4.7 Store the fibers temporarily on a tray (picture shows the case of a loopback).

4.8 Storing dark fibers can be done in different ways.

- 1) Organise dark fibers into the different trays, following instructions as described.
- 2) Organise dark fibers together into the first available tray (i.e. with a max. of 24cut or 12 loops primary coated fibers in one SE-tray).

5 Trays

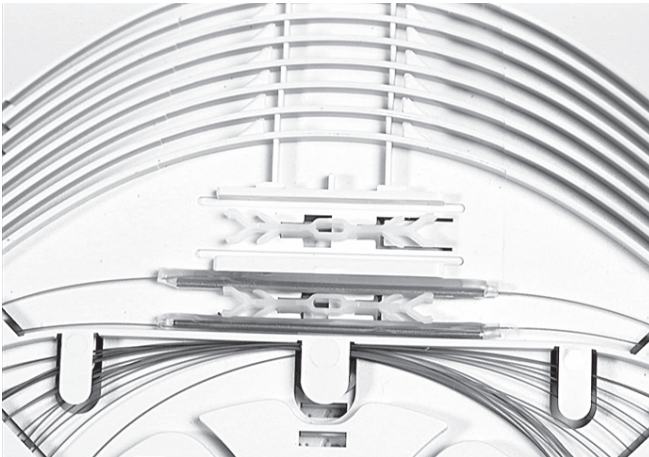

5.1 SMOUV in SC tray.

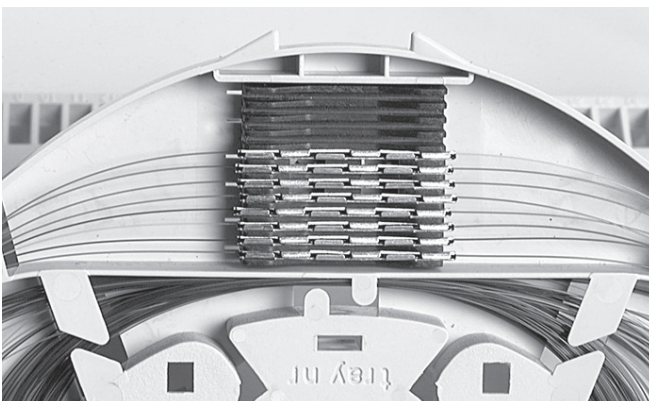

5.2 ANT in SE tray.

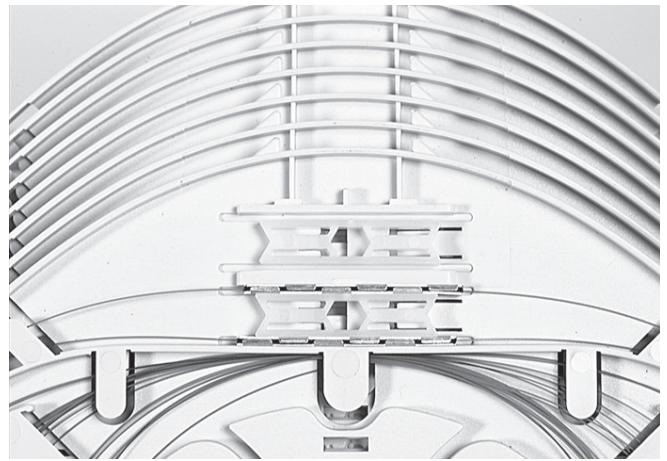

5.3 ANT in SC tray.



5.4 RECORDsplice in SC tray.

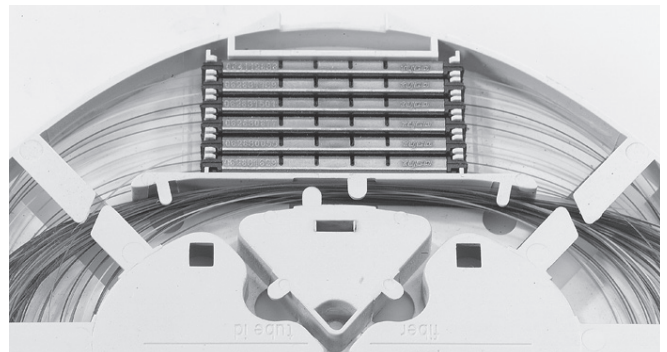

5.5 RECORDsplice in SE tray.

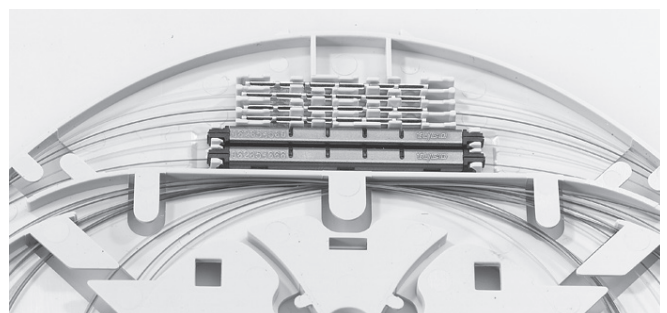

5.6 RECORDsplice/ANT in SC tray.

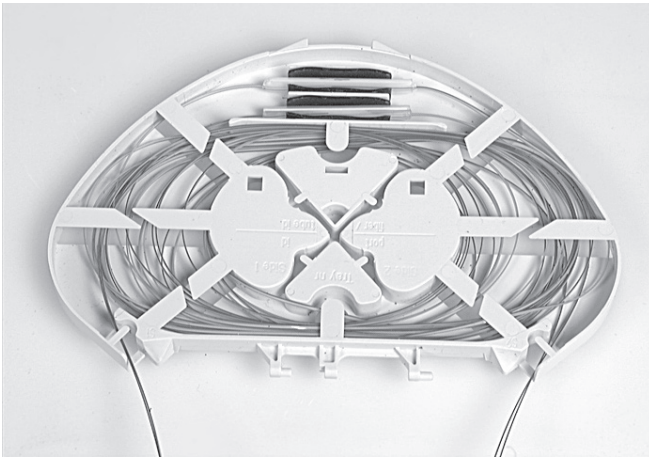

5.7 Ribbon 4/8 tray.

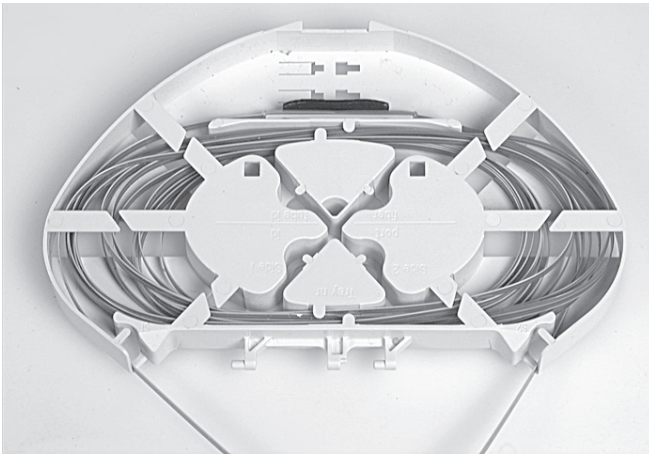

5.8 Ribbon 12 tray.

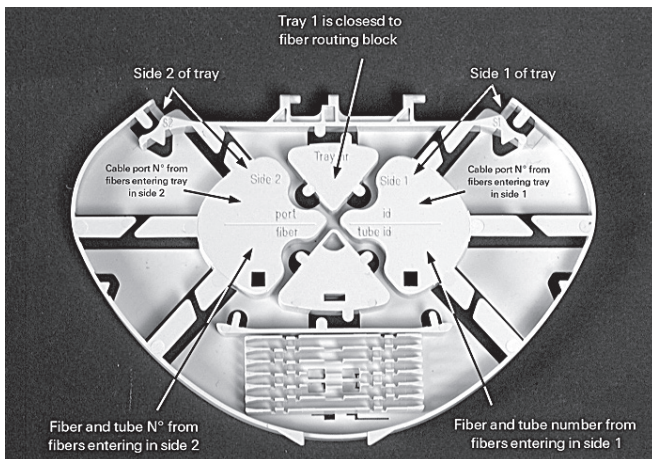

5.9 Use a permanent marker to write on the tray.

6 Closing the box

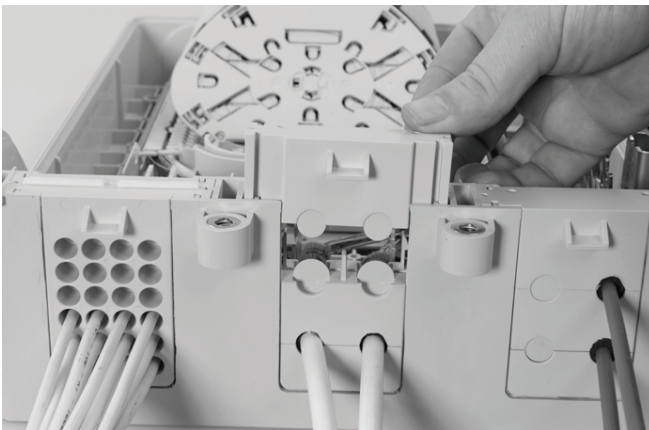
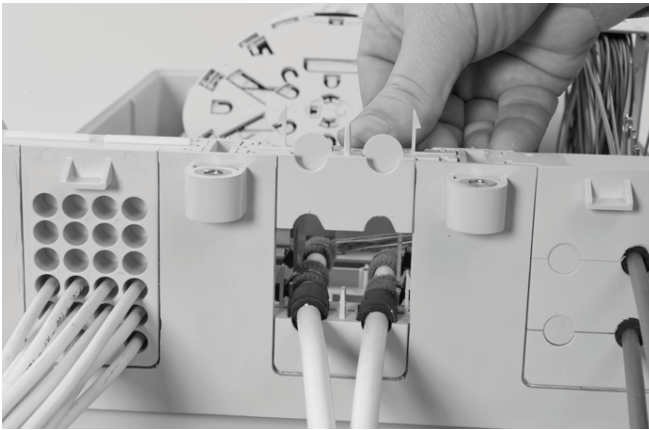
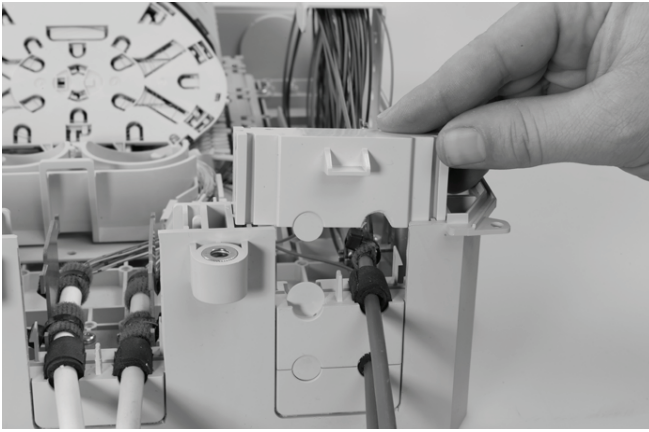

6.1 Close all the ports.



6.2 Close the box.

To find out more about CommScope® products, visit us on the web at www.commscope.com

For technical assistance, customer service, or to report any missing/damaged parts, visit us at:
<http://www.commscope.com/SupportCenter>

© 2017 CommScope, Inc. All rights reserved.

SMOUV, RECORDsplice and all trademarks identified by ® or ™ are registered trademarks or trademarks, respectively, of CommScope, Inc.

This document is for planning purposes only and is not intended to modify or supplement any specifications or warranties relating to CommScope products or services.

This product is covered by one or more U.S. patents or their foreign equivalents. For patents, see:
www.commscope.com/ProductPatent/ProductPatent.aspx.

TC-1231-P
 Rev A, Apr 2017
 www.commscope.com

Building distributor

Introduction

The Budi is a building distributor for a fiber management system that offers the functions of splicing and patching. It provides mechanical and environmental protection for the fiber optic components.

Kit content

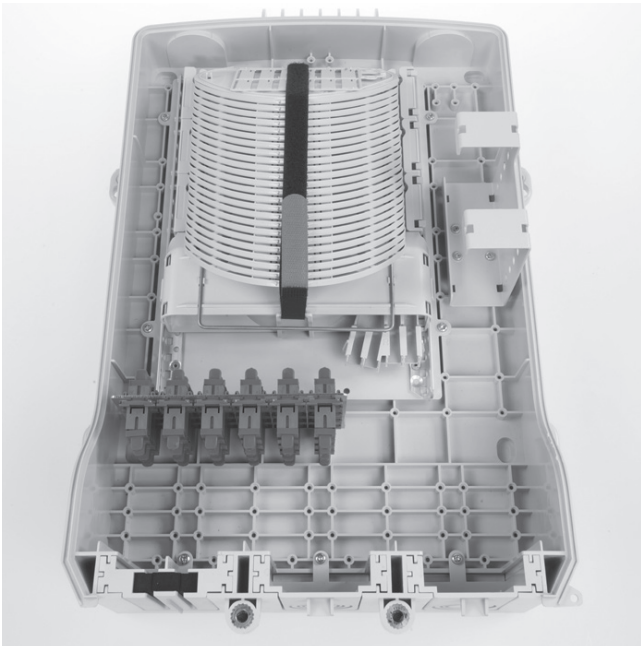

- Box

Accessories

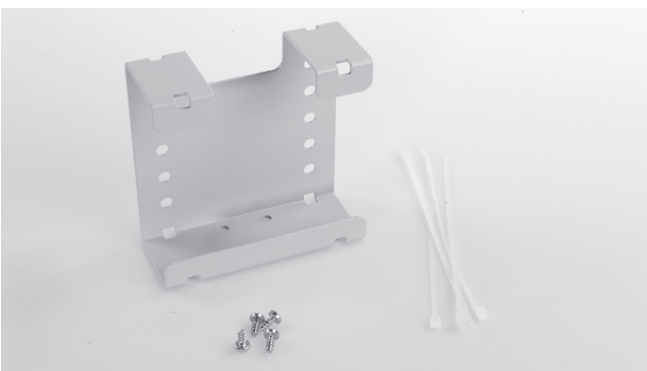

- Loop bracket
 Loop of 8 loose tubes (Ø 2,4 mm).
 Maximum window of 2,6 m.

Seals

Wrap around cable seals

Sealblock 4 x 10 mm

Cable diameter (mm)	Foam (± 5 mm)
3	95
4	90
5	80
6	75
7	70
8	60
9	50
10	40

Sealblock 4 x 15 mm

Cable diameter (mm)	Foam (± 5 mm)
9	125
10	115
11	105
12	95
13	85
14	70
15	60

Sealblock 2 x 20 mm

Cable diameter (mm)	Foam (± 5 mm)
14	155
15	140
16	125
17	110
18	95
19	85
20	75

Sealblock 24 x 8 mm
 Cable range 1,8 - 7 mm

Sealblock rubber 1 x 18 mm
 To use in ports S4-S5 only
 Cable range 3 - 18 mm

Pigtail seal 48

Standard seals

- PG 16
- PG 21
- PG 29
- PG 29 (PTS 24)

1 Preparation of the box

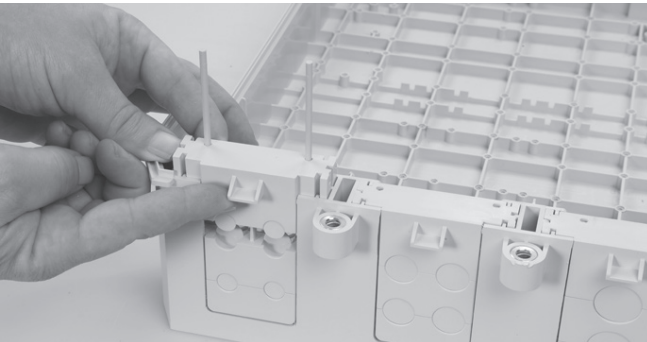
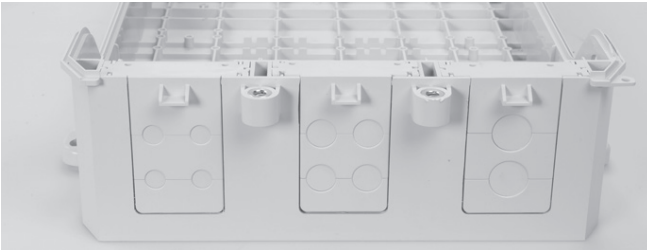
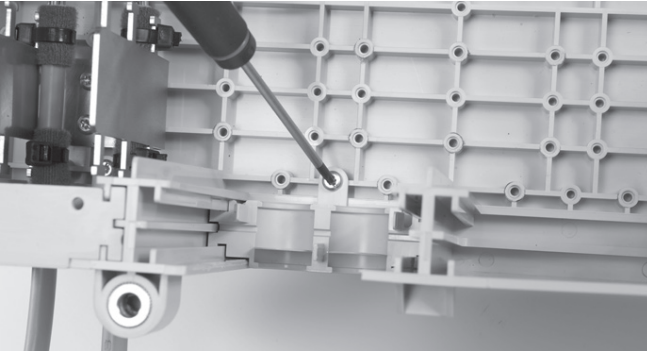

1.1 Different wrap around ports are available (including brackets). Use two guiding pins to open the ports and to secure the bottom part to the box. Cut out the plasti part if you want to install a cable.

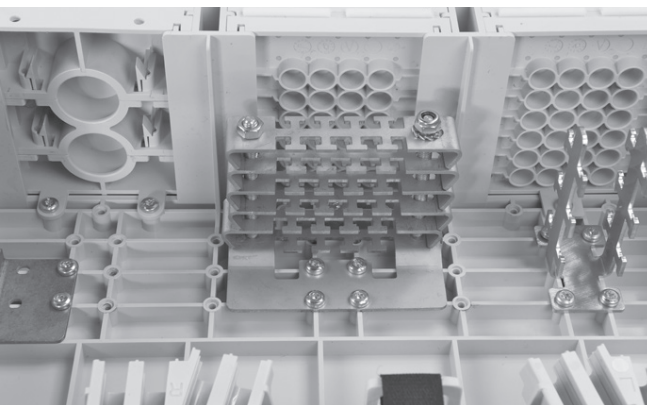

1.2 Install the cable bracket depending on the cable seal.

2 Looped cable

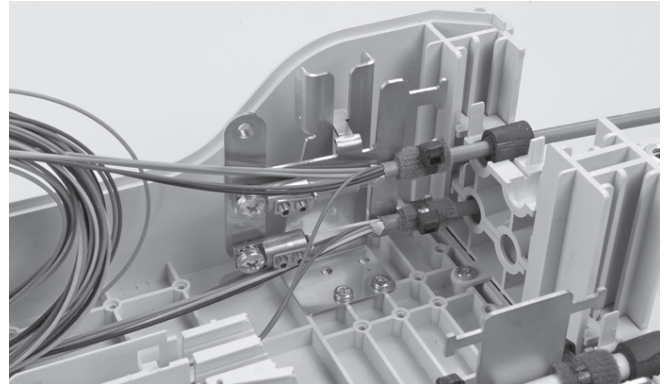

2.1 Install the looped cable into the ports.

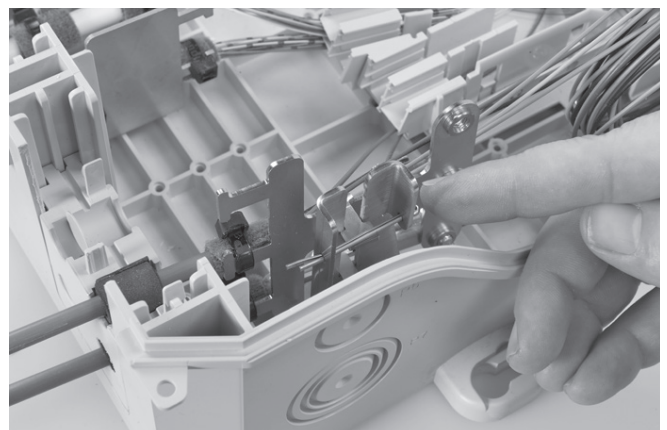
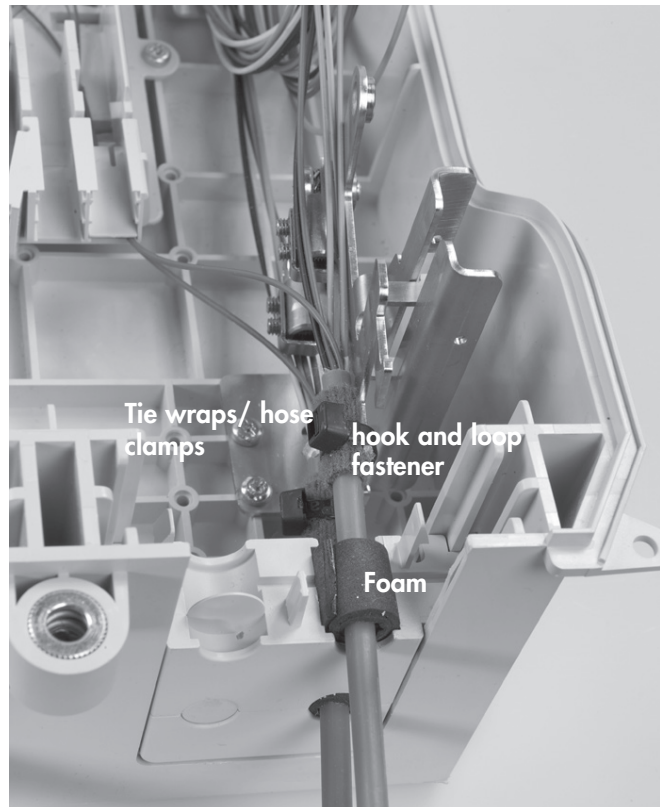

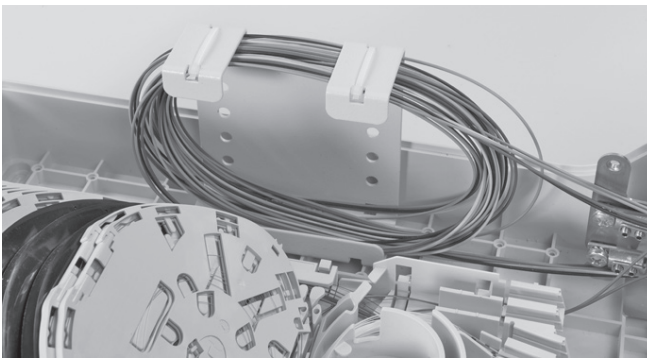

2.2 Store the looped tubes into the loop bracket.

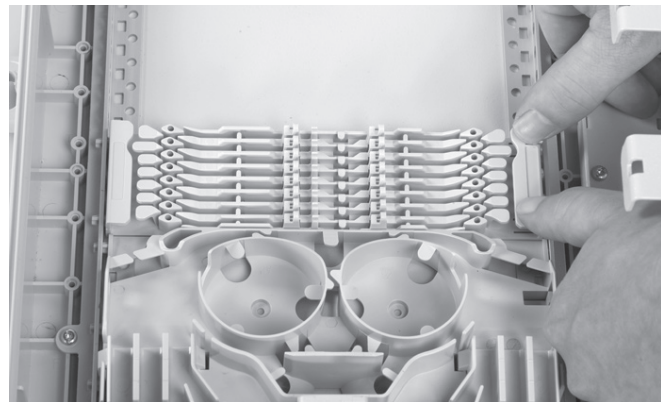

3.2 To remove push the two snapfits at S2 UMS-profile and slide the wraparound plate towards S1 UMS-profile.

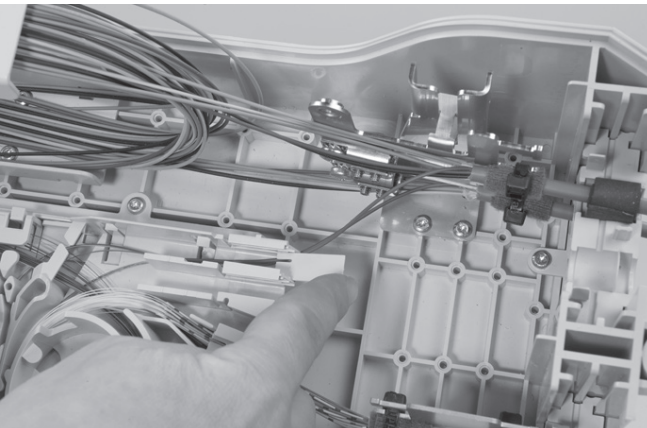

2.3 Route the loose tube towards the FAS block.



3 Fiber routing

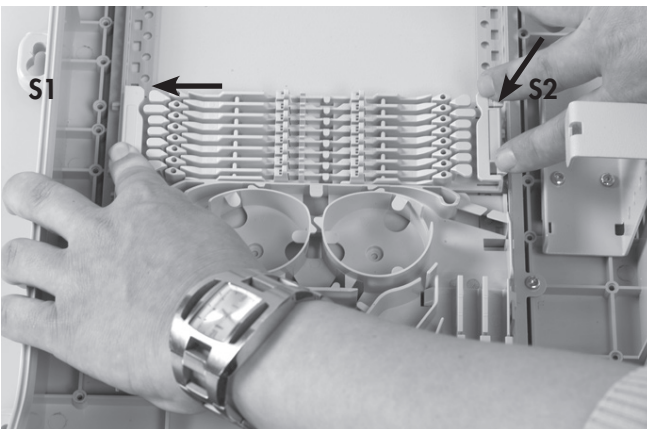

3.1 Secure the wraparound groove plate on the UMS by putting the plate with the long protrusions in the S1 UMS-profile and sliding the plate in the S2 UMS-profile until it snaps. (Do not leave gaps between groove plates).



3.3 Place a tray in the wraparound groove plate; do this by pushing the lip on the groove plate (lowest possible position) slightly down with the tray and move the tray lateral into the hinge-cavities of the groove plate. To snap the High Capacity Single Element tray (HCSE) in the W/a single fiber groove plate **leave always one hinge facility open between Fasblock or previous tray and the HCSE-tray.**

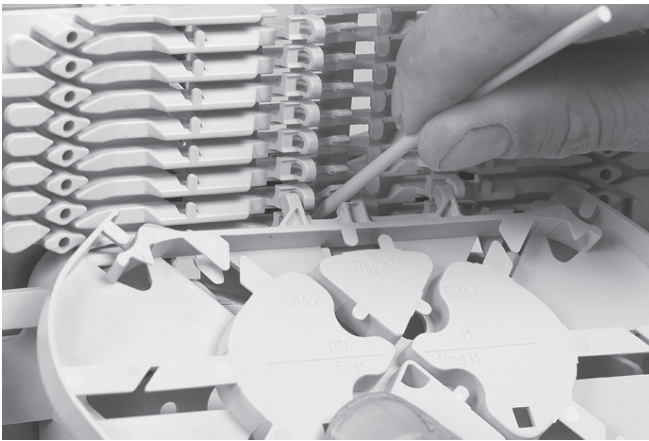

3.4 To remove the tray put the fiber guiding pin between lip on wraparound groove plate and tray and move lateral towards S1.

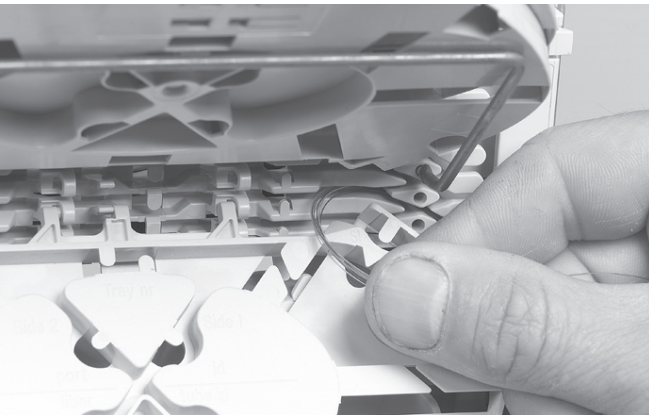

3.5 Position the wedge carefully so that the groove is still accessible for the fibers and can be careful not to push the wedge against fibers. To remove the wedge, use two hands to pull on both ends (near the groove plate). Route the fiber in the grooves of the wraparound groove plates to the entrance of the identified tray. Fiber must be routed in the groove below the hinge of the tray!

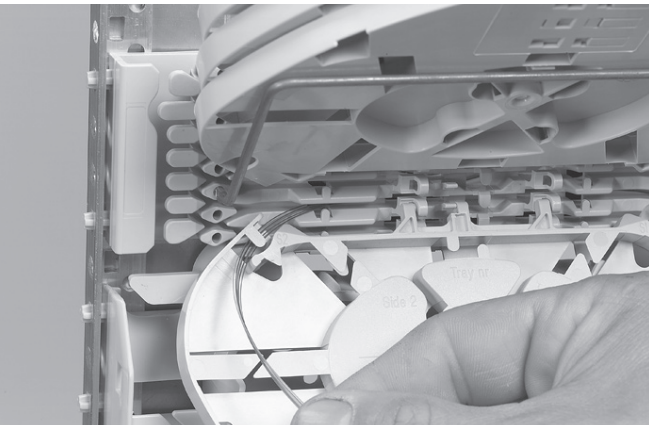

3.6 Pull gently on the fibers in the tray and make sure that the fibers are well contained in the routing block and wraparound groove plate.

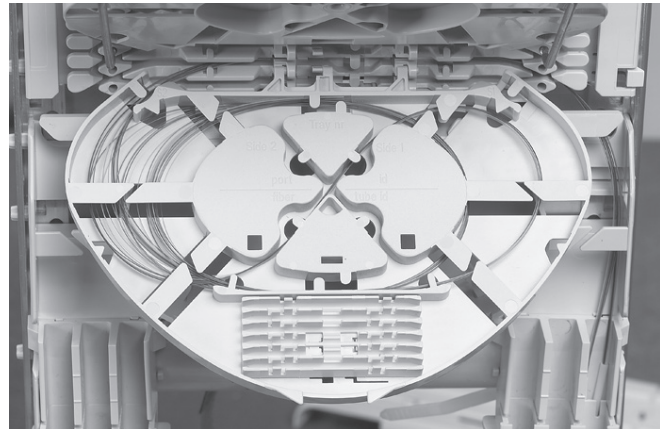

3.7 Store the fibers temporarily on a tray (picture shows the case of a loopback).

3.8 Storing dark fibers can be done in different ways:

- 1) Organise dark fibers into the different trays, following instructions as described.
- 2) Organise dark fibers together into the first available tray (i.e. with a max. of 24 cut or 12 loops primary coated fibers in one SE-tray).

4 Pigtail routing

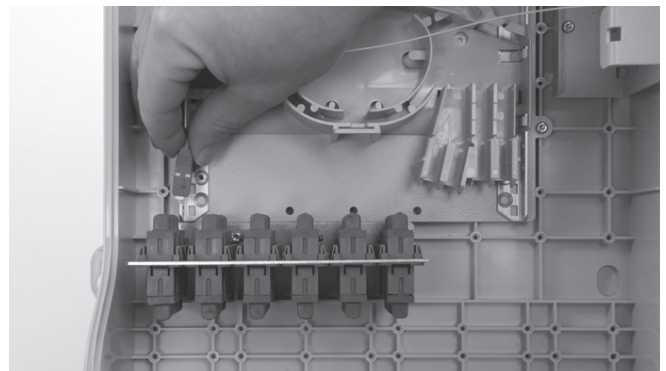

4.1 Install the 900µm pigtails into the designated adaptor.

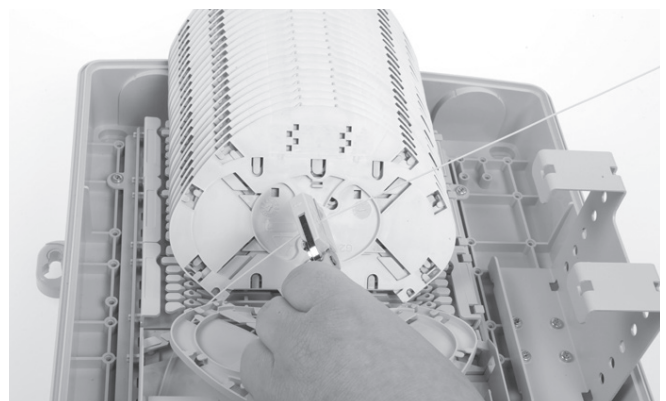

4.2 Strip the 900µm half way to the groove before entering the tray. In case you do not strip the pigtail, only 0,8m can be stored into the tray.

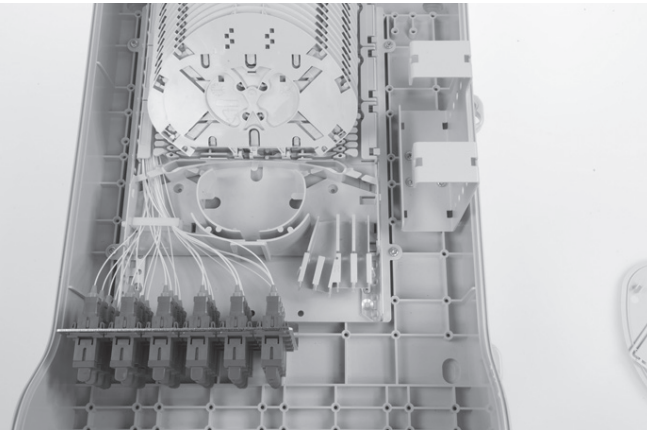
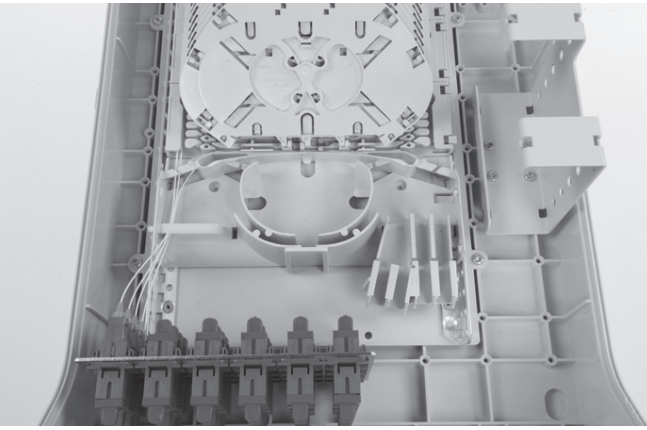

4.3 All pigtails installed.

5 Trays



5.1 SMOUV in SC tray.

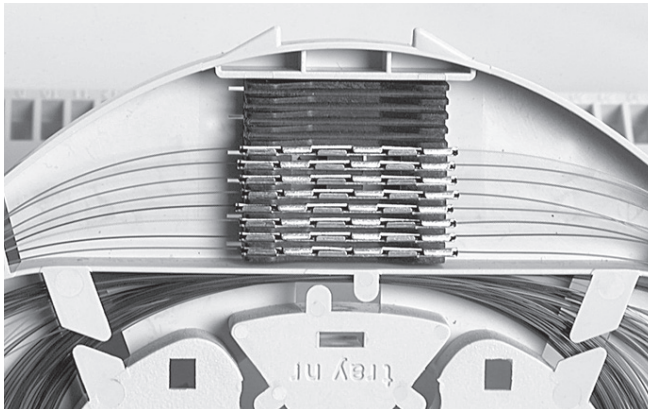

5.2 ANT in SE tray.

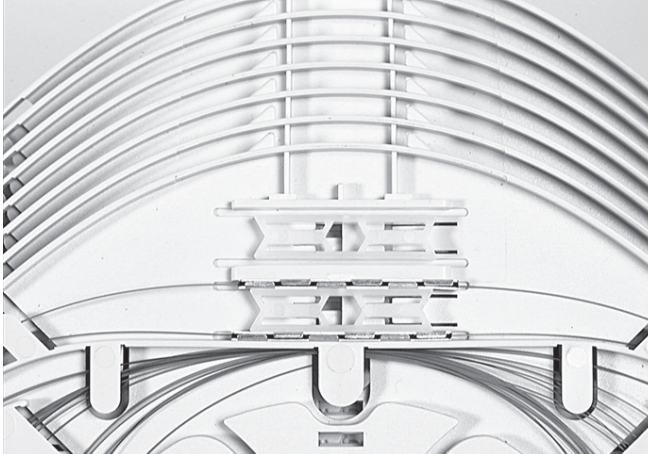

5.3 ANT in SC tray.



5.4 RECORDsplice in SC tray.

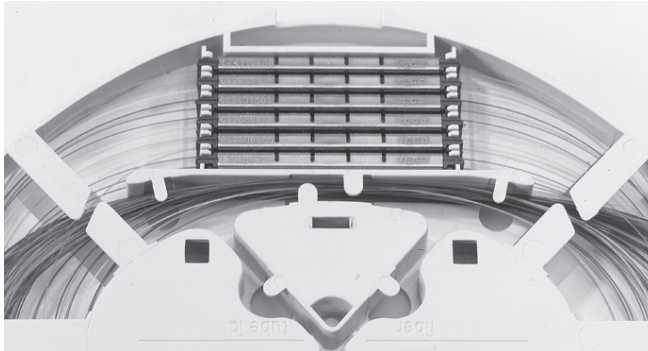

5.5 RECORDsplice in SE tray.

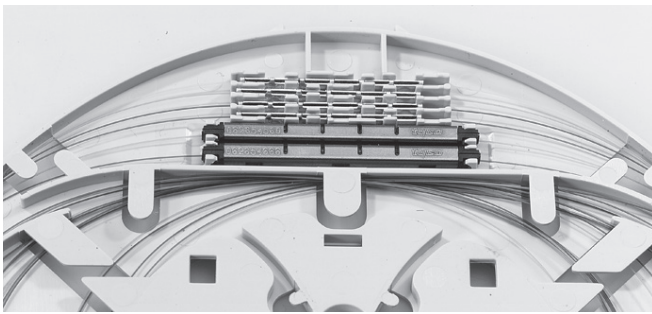

5.6 RECORDsplice/ANT in SC tray.

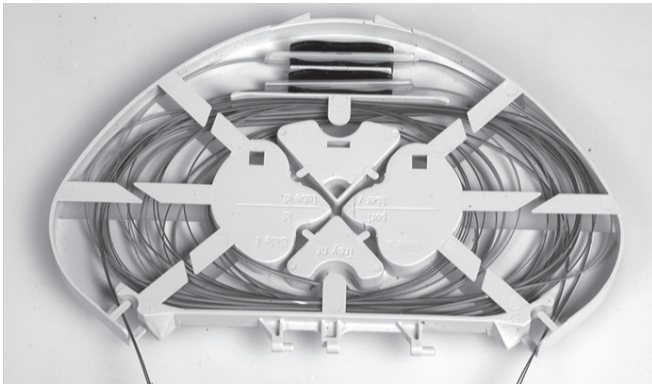

5.7 Ribbon 4/8 tray.

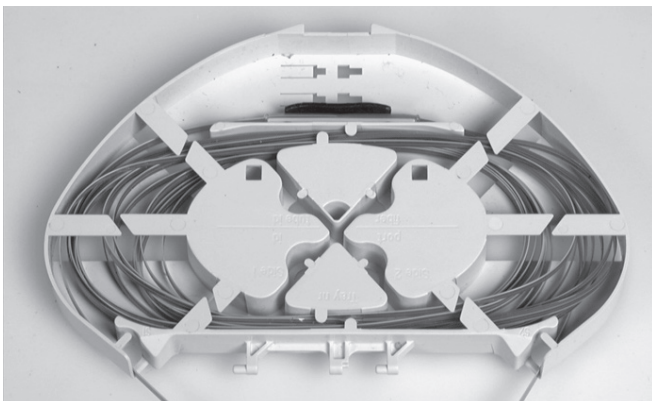

5.8 Ribbon 12 tray.

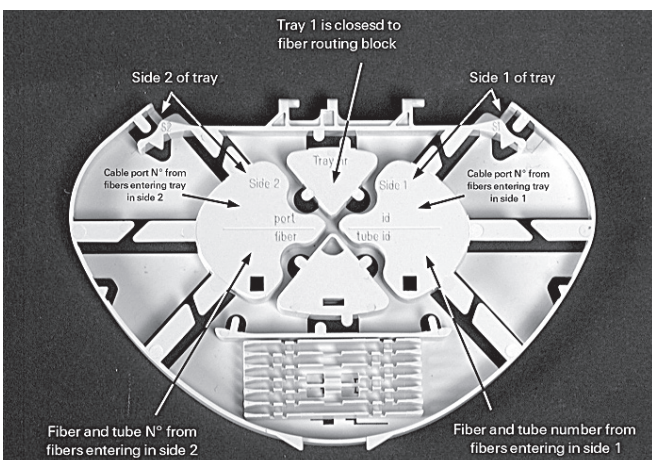

5.9 Use a permanent marker to write on the tray.

6 Patchcord routing

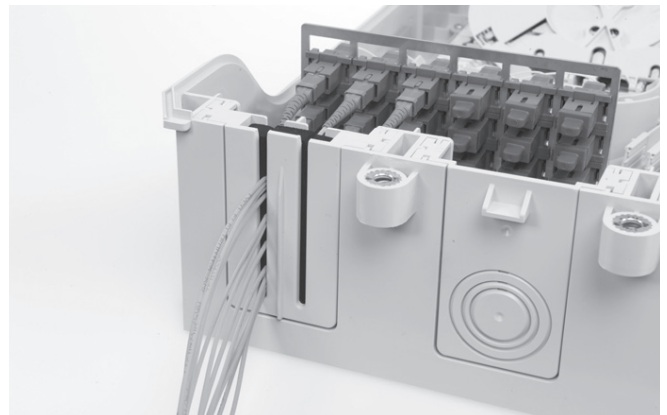
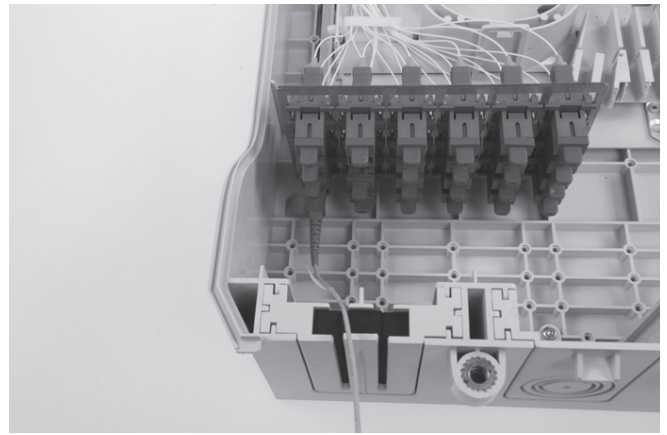

6.1 Install the first 12 patchcords into the designated adaptors. Route these into the left groove of the seal.

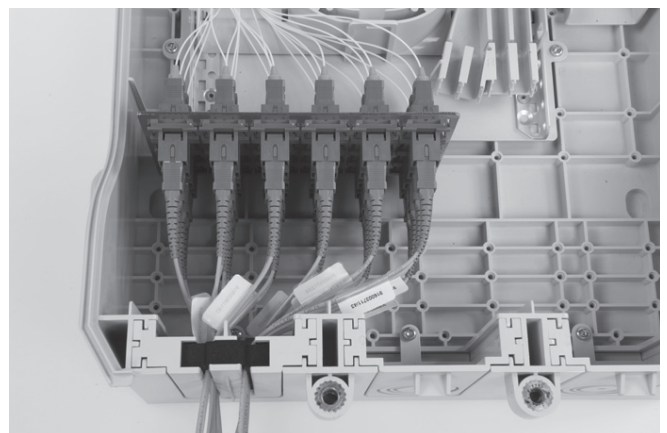

6.2 Install the next 12 patchcords and route these into the second groove of the seal.

7 Closing the box

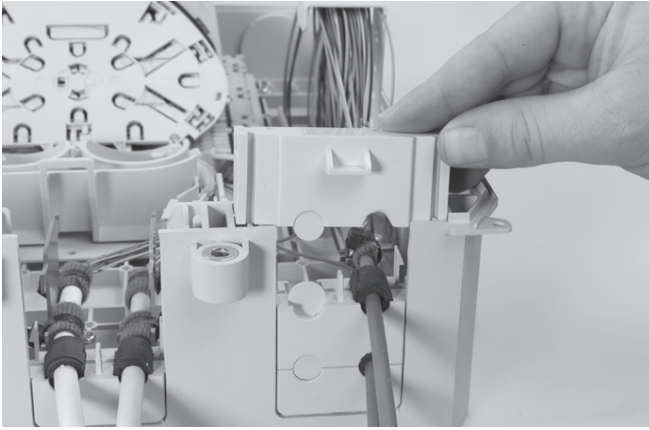

7.1 Close all the ports.

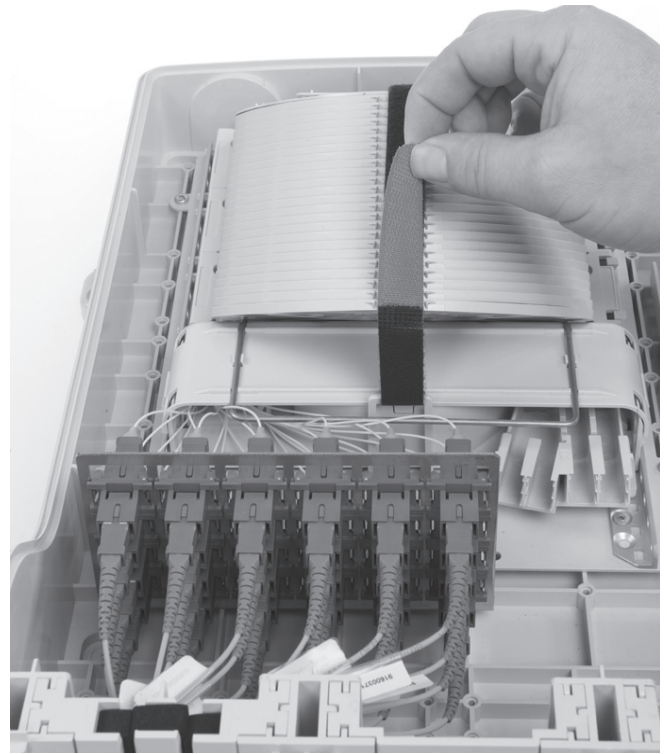
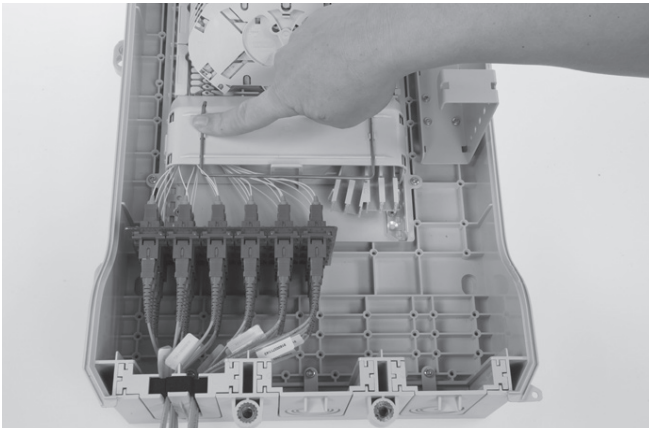

7.2 Close the FAS block and place the cover onto the last tray. Secure with the hook and loop fastener.

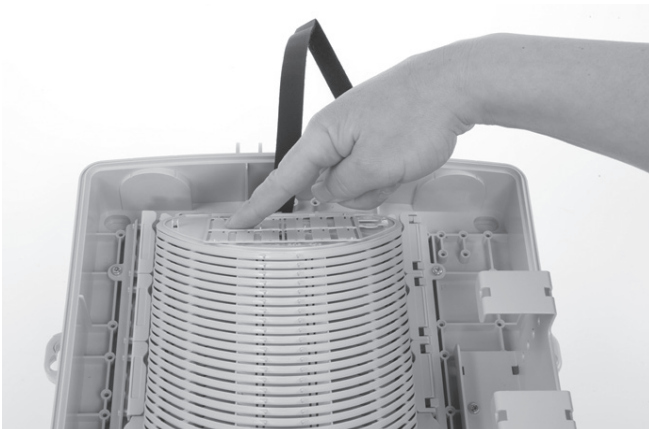

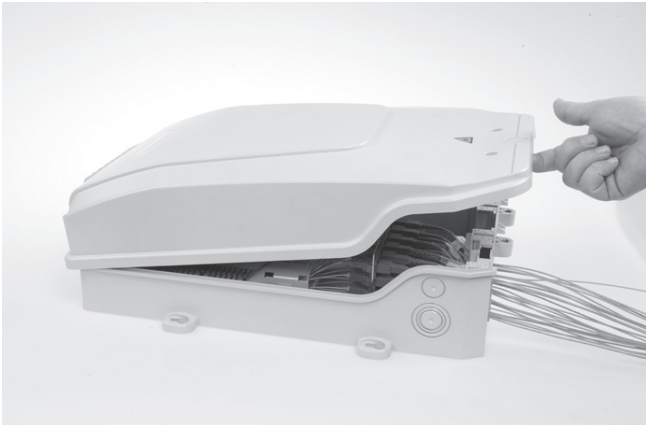

7.3 Close the box.

To find out more about CommScope® products, visit us on the web at www.commscope.com

For technical assistance, customer service, or to report any missing/damaged parts, visit us at: <http://www.commscope.com/SupportCenter>

© 2017 CommScope, Inc. All rights reserved.

All trademarks identified by ® or ™ are registered trademarks or trademarks, respectively, of CommScope, Inc.

This document is for planning purposes only and is not intended to modify or supplement any specifications or warranties relating to CommScope products or services.

This product is covered by one or more U.S. patents or their foreign equivalents. For patents, see: www.commscope.com/ProductPatent/ProductPatent.aspx.