

TC-1212-IP
Rev A, Apr 2017
www.commscope.com

1 General

Smallest splice/patch enclosure of the BUDI family using FIST with a maximum of 12 connections.

2 Kit content



3 Feeder cable installation

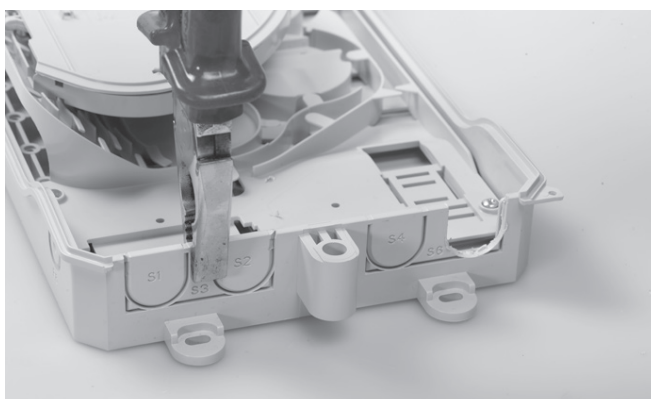
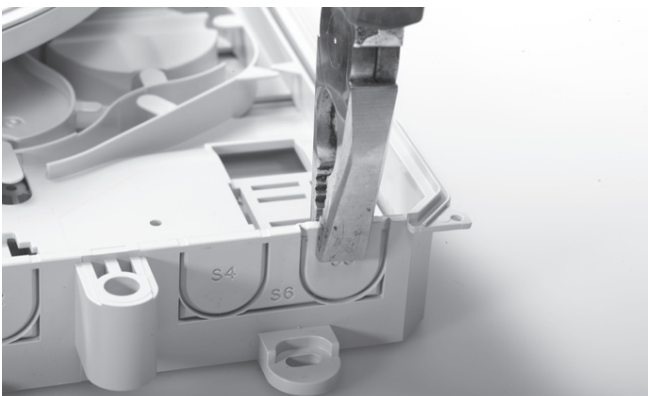

3.1 Open up feeder and drop cables entries.

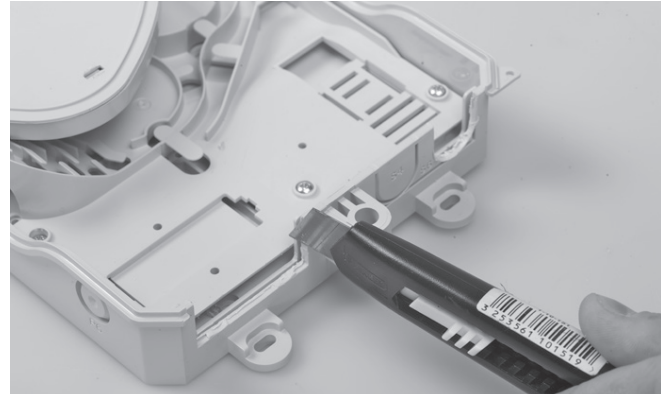

3.2 Remove all burrs and sharp edges from the cable entries with a sharp knife (e.g. carpet cutter).

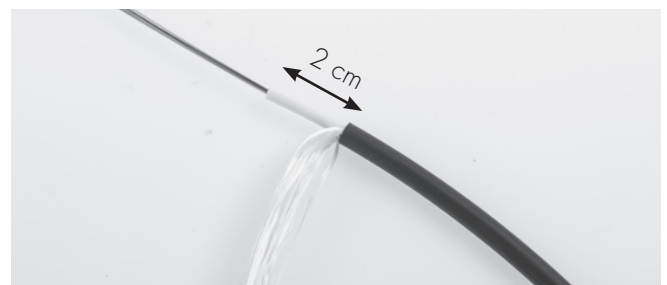

3.3 Strip the feeder cable (1,5 m) and strip the loose-tube leaving 2 cm of it.

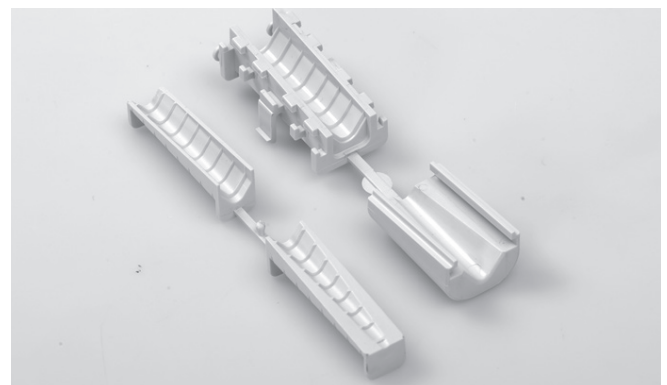

3.4 Break off the parts needed for feeder cable termination.

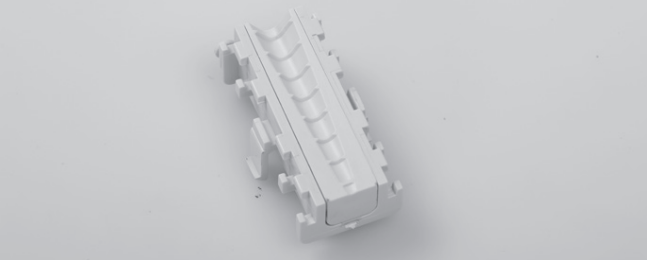

3.5 Install the insert into the cable holder depending on the cable diameter (2 inserts are available).

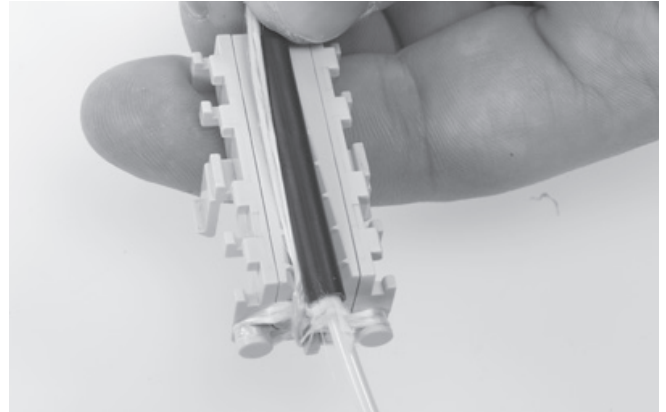
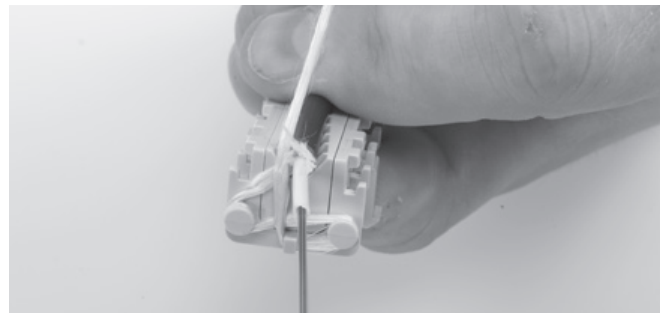

3.7 Route the aramid yarns around the lips as shown.

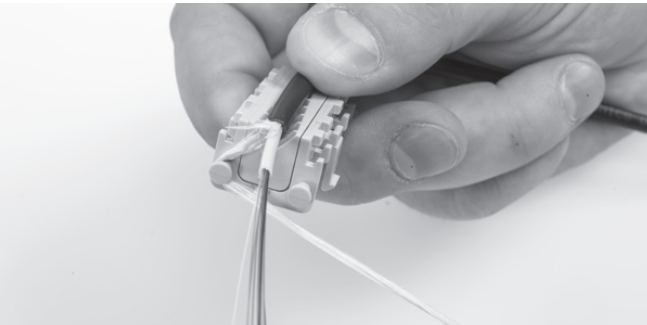

3.6 Install the feeder cable into the cable holder.

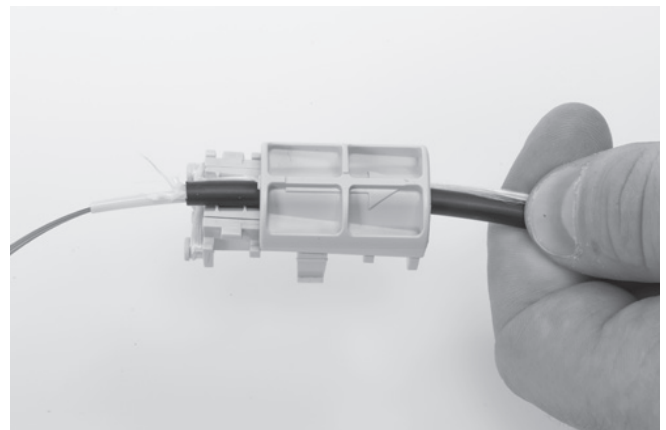
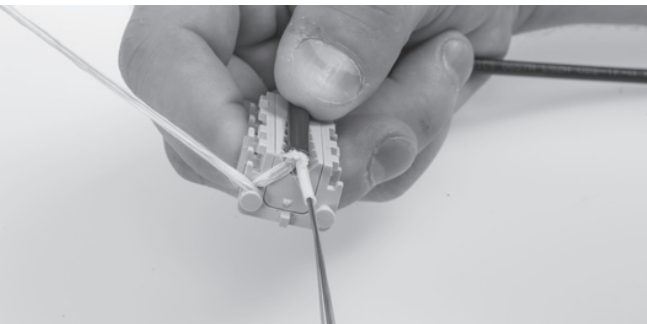
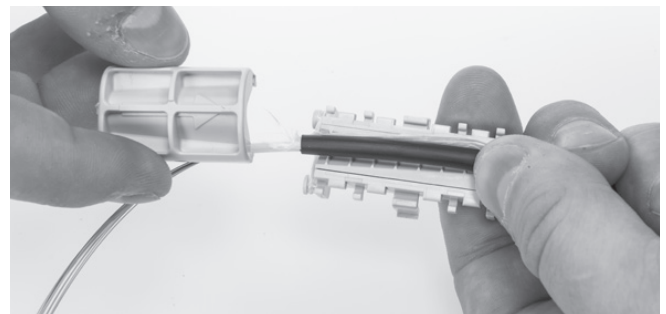

3.8 Close the cable holder by sliding the cover over the base (orientation arrow towards the cable) and cut of the rest of aramid yarns.

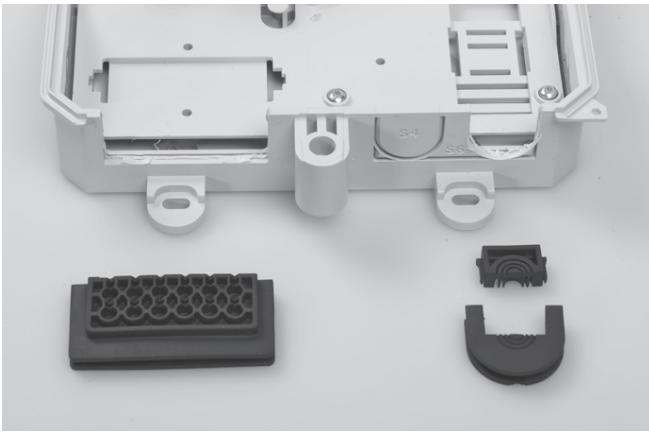

3.9 Install the grommets.

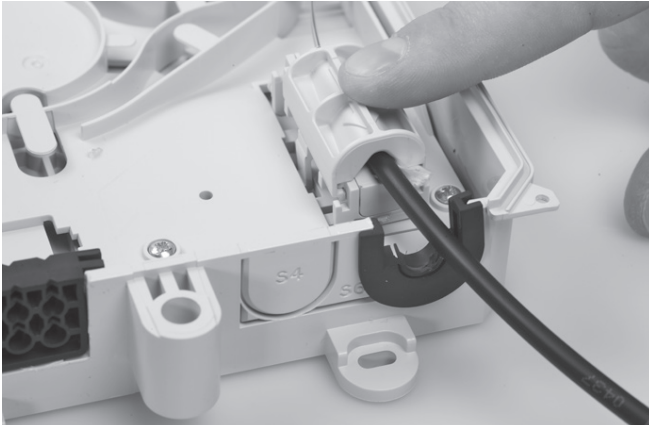
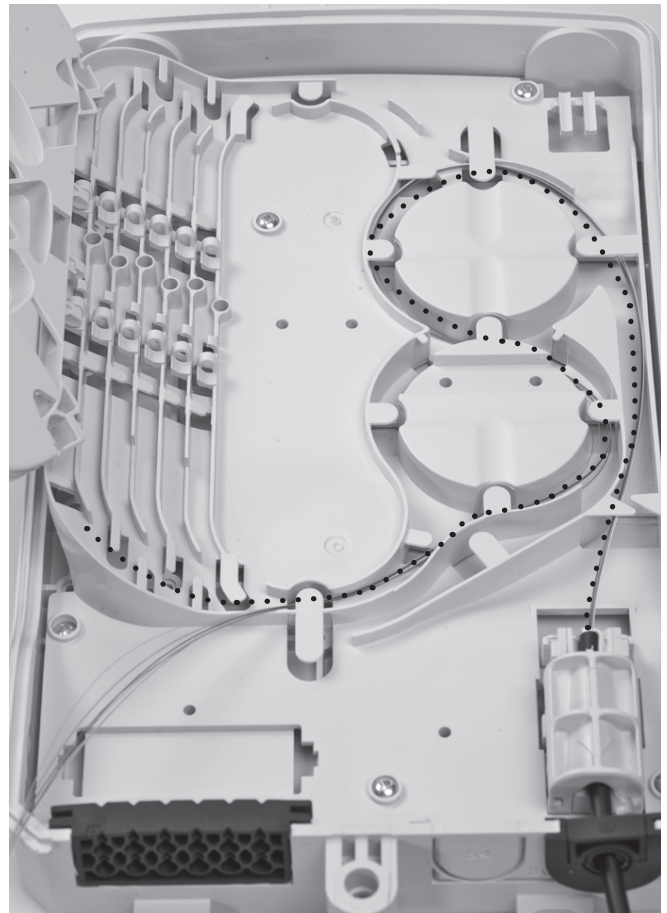

3.10 Install the cable holder into the box on the lowest position (adjust the position depending on the cable diameter).

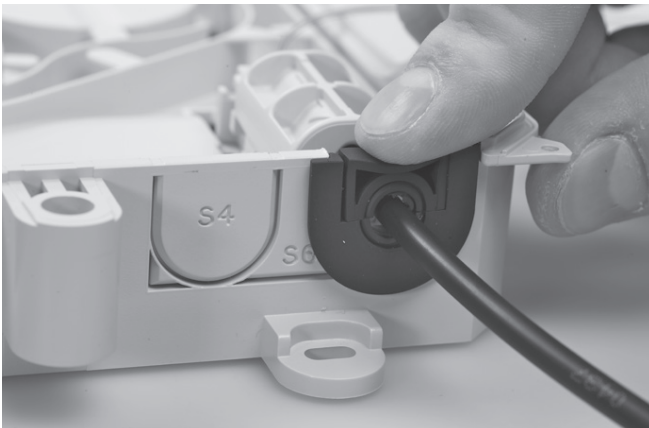

3.11 Install the second part of grommet to seal the box.



3.12. Route the fibers to be spliced towards to the tray trough the Box as shown.

4 Patch panel installation

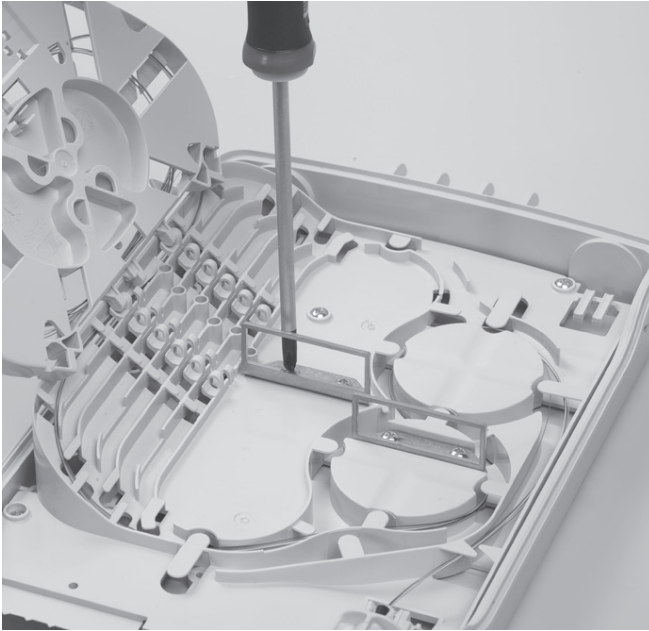

4.1 Install the patch panels.

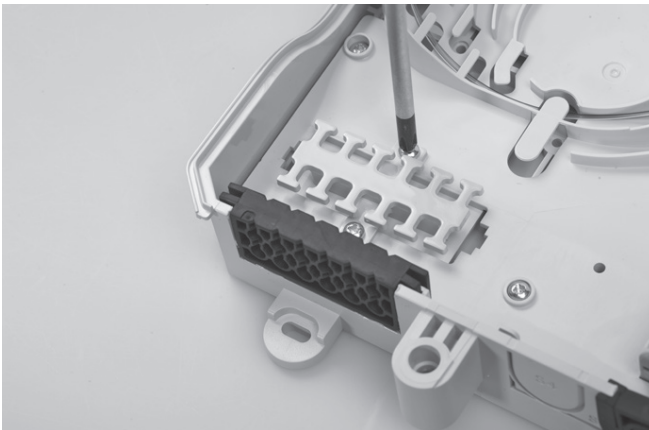

4.2 Install the strain relief for drop pigtails.

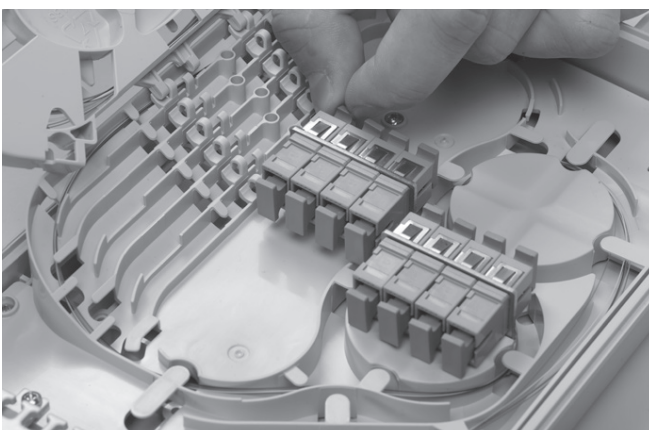

4.3 Insert the adapters and remove the plugs.

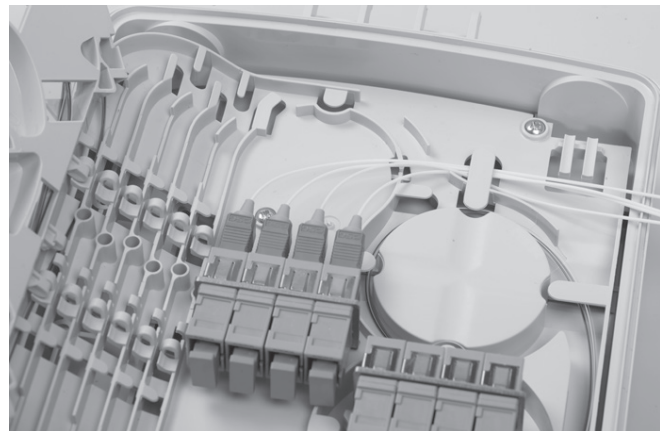

4.4 Connect first four 900µm pigtails.

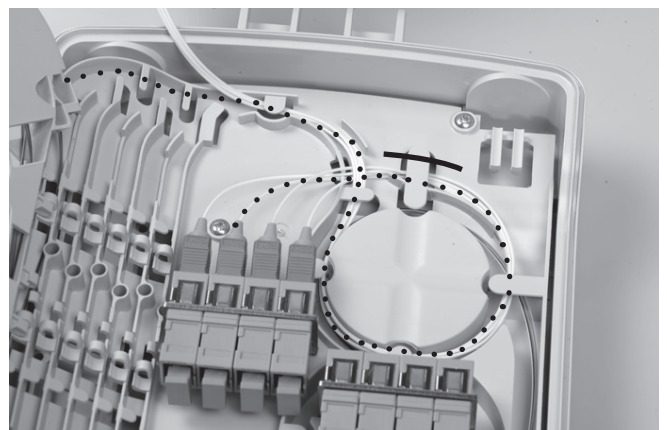

4.5 Route the first four 900µm pigtails to be spliced towards to the tray trough the Box as shown.

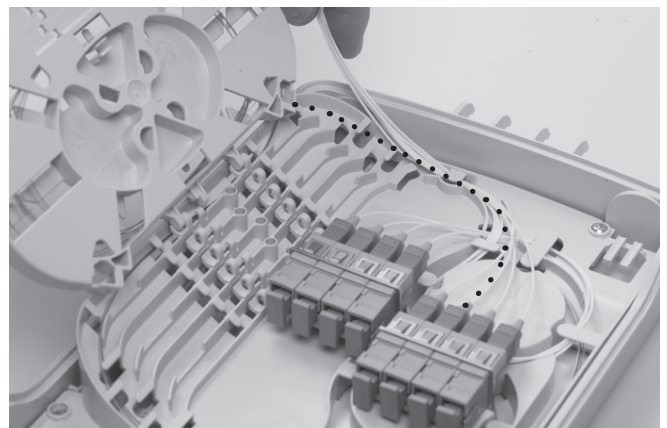

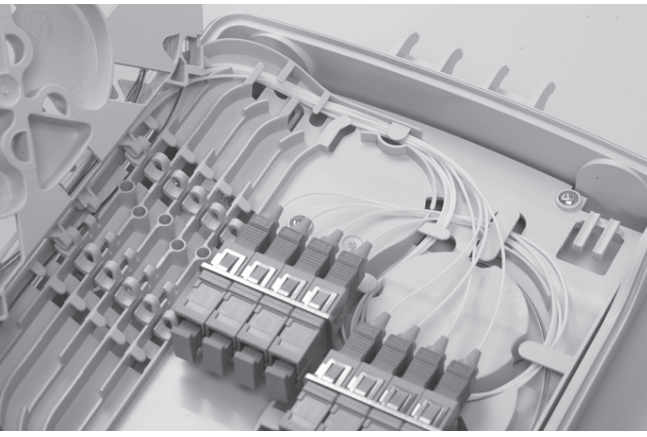

4.6 Connect the rest of the 900 μ m pigtailed and route them towards to the tray through the Box as shown.

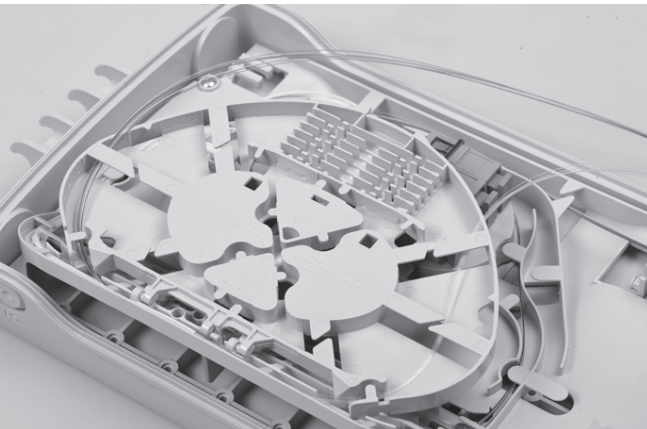
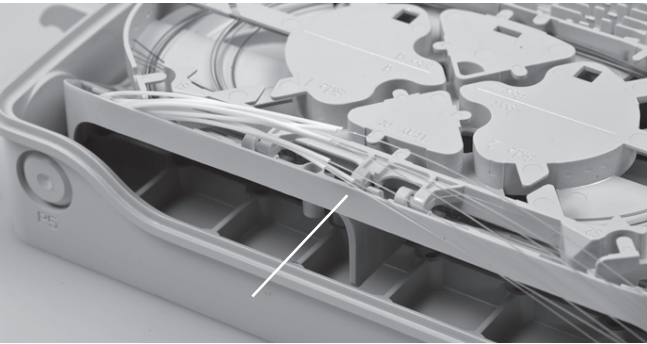

4.7 Strip the 900 μ m pigtailed at the marked position.



4.8 Splice the fibers from the feeder cable to the pigtailed and store the overlength into the tray.

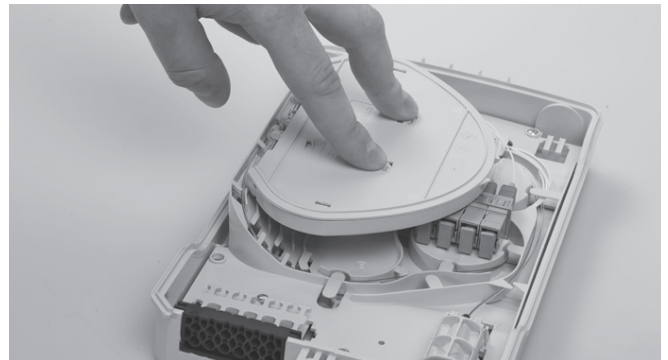

4.9 Install the cover onto the tray.

5 Drop cables installation

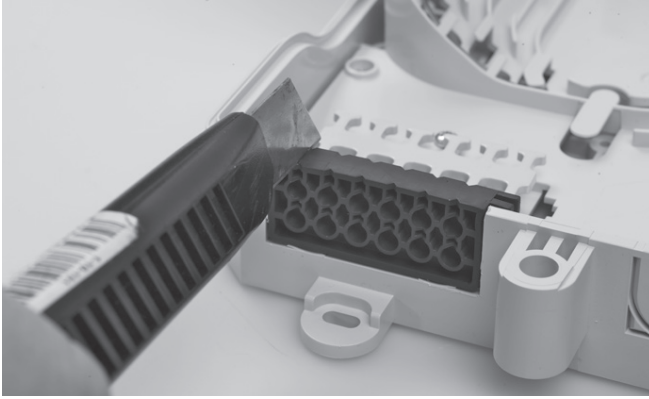

5.1 Cut the grommet where the drop cable will be installed.

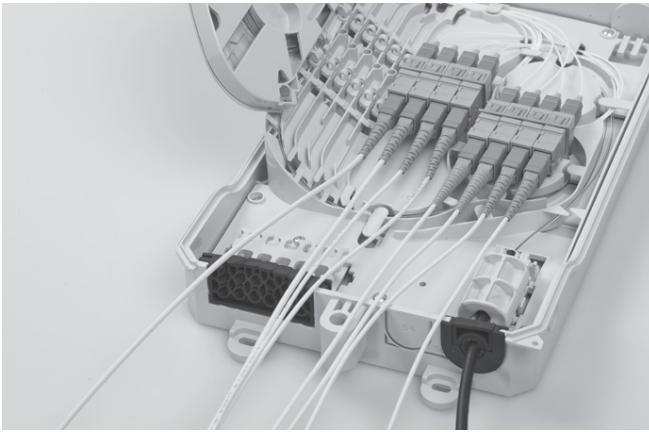

5.2 Connect all the drop cables.

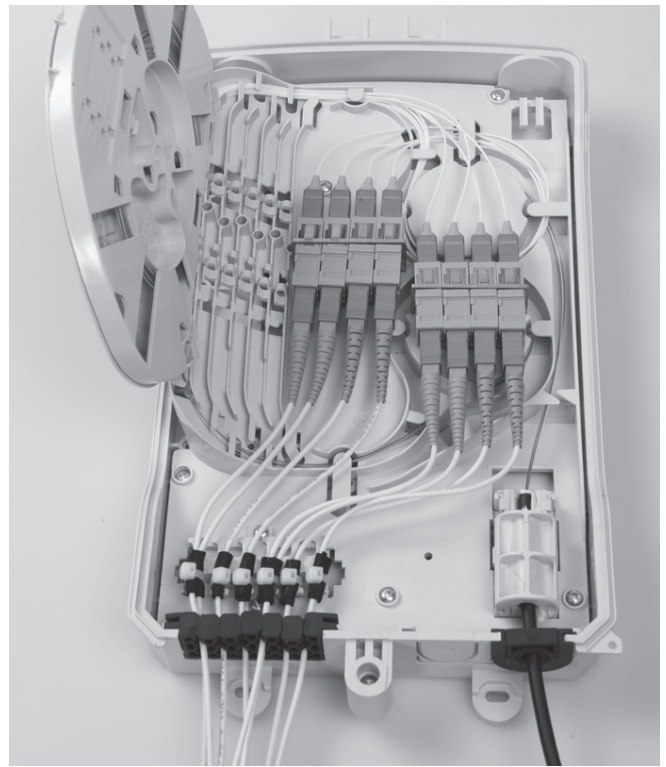
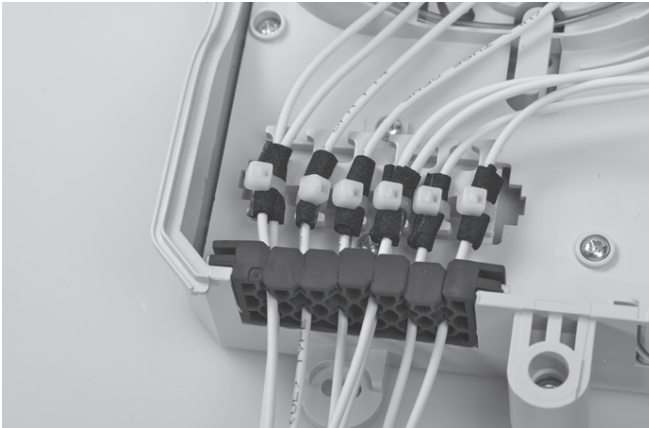

5.3 Apply the foam and secure with tie-wraps as shown.

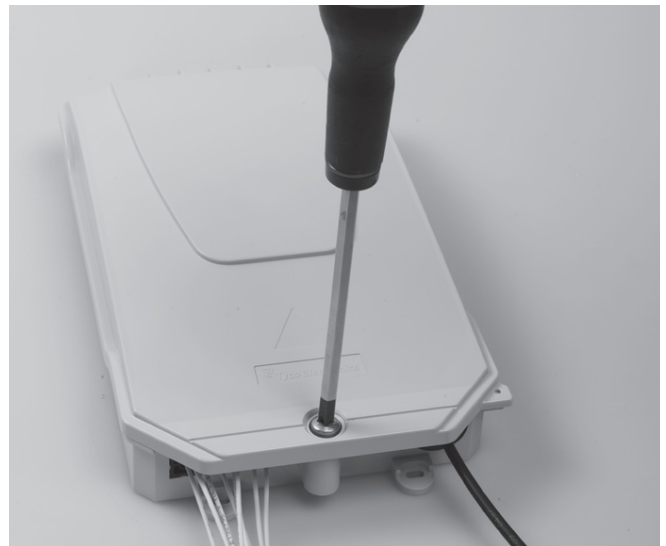

5.4 Install the cover and secure with the screw.



5.5 Installed box.

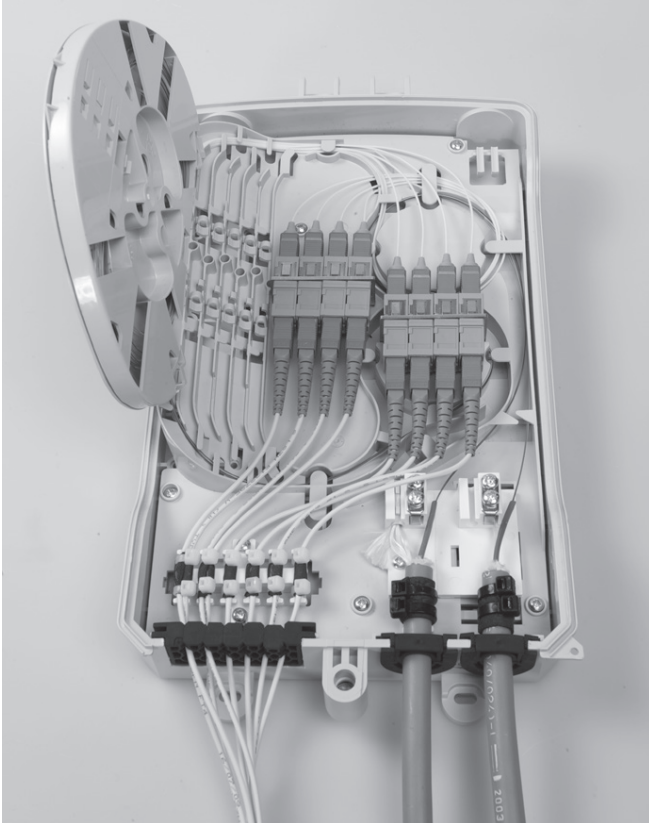

5.6 Installed box with two feeder cables (optional).

To find out more about CommScope® products, visit us on the web at www.commscope.com

For technical assistance, customer service, or to report any missing/damaged parts, visit us at:
<http://www.commscope.com/SupportCenter>

© 2017 CommScope, Inc. All rights reserved.

All trademarks identified by ® or ™ are registered trademarks or trademarks, respectively, of CommScope, Inc.

This document is for planning purposes only and is not intended to modify or supplement any specifications or warranties relating to CommScope products or services.

This product is covered by one or more U.S. patents or their foreign equivalents. For patents, see:
www.commscope.com/ProductPatent/ProductPatent.aspx.

TC-925-IP
Rev A, Mar 2017
www.commscope.com

Building distributor

Introduction

Suitable for FTTH applications where easily pre-connectorized splitters modules can be build in.

1 Kit configurations



1.1 Blown fiber application , no splitter configuration.



1.2 Blown fiber application, with splitter configuration.



1.3 Drop cable application.

2 Installation

2.1 Drop cable application

2.1.1 Strip the outer jacket over a length of 1.5 m and leave some aramid strength member to install onto the termination unit.



2.1.2 Install the termination unit onto the cable.

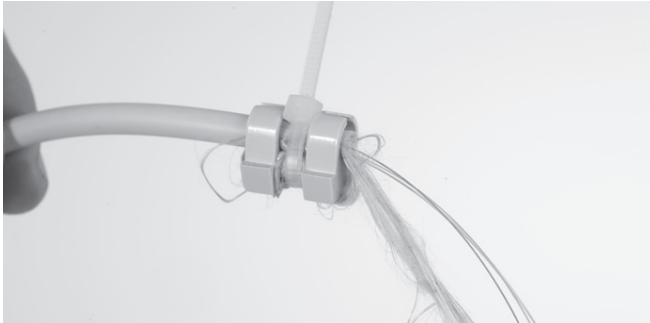
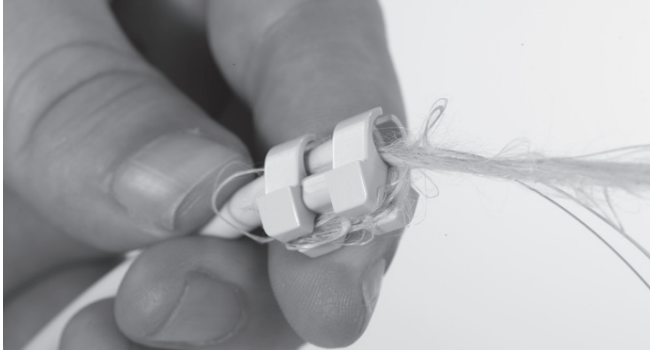
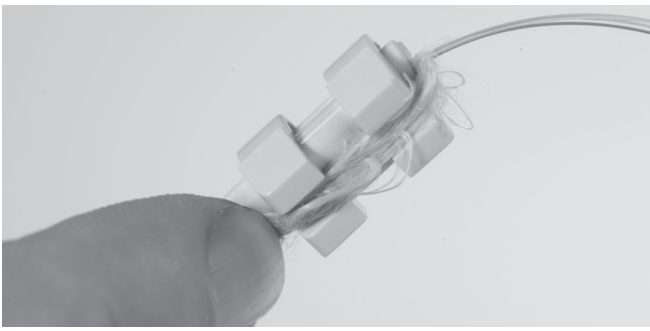

2.1.3 Slide the termination unit to the end of the outer jacket and route the aramid strength member in the groove under need the termination unit and route the aramid strength member back to the front in between the termination unit and the outer jacket. Install a tie-wrap around the termination unit and the cable.

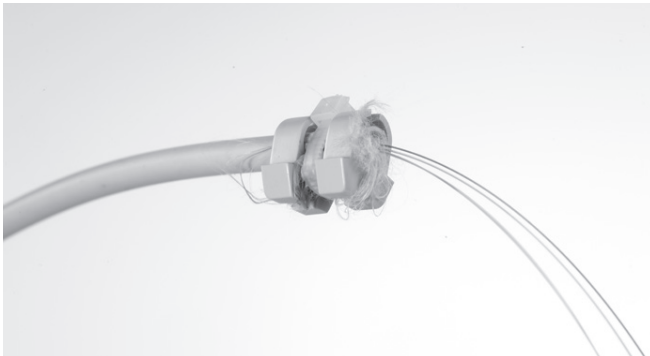

2.1.4 Cut the overlength of the aramid strength member.

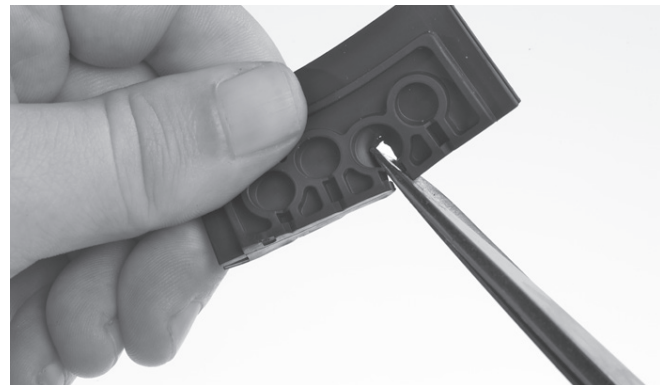

2.1.5 Cut into the rubber seal to open the cable port.

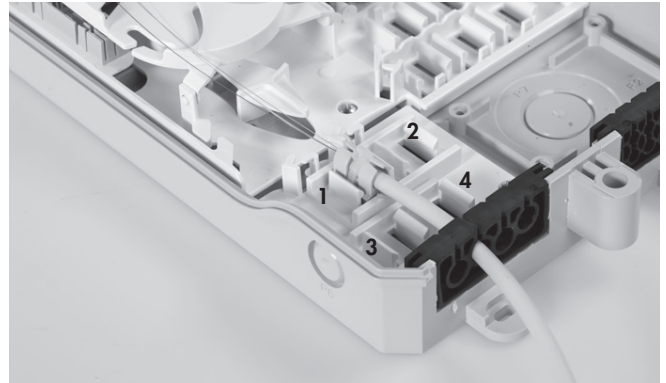

2.1.6 Install the cable with the termination unit into the box, Click the termination unit in one of the ports foreseen for the termination units and install the cable in the rubber seal. Start with termination unit positions 1, 2, 3 and finally 4.

2.2 Blown fiber application

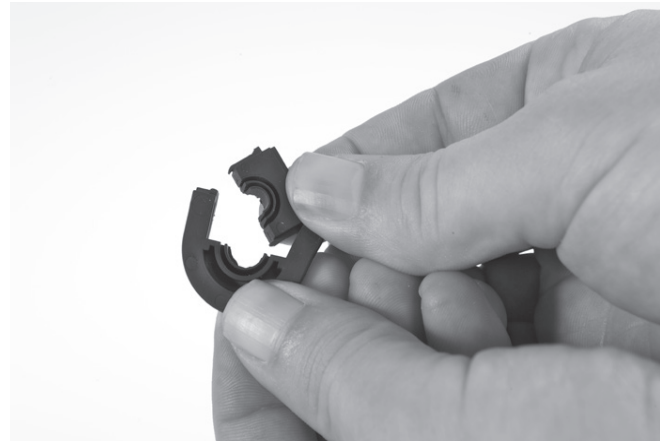

2.2.1 Open the wrap around rubber seal.

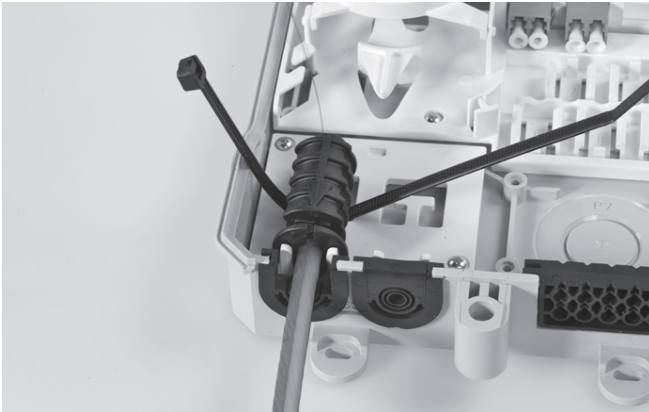
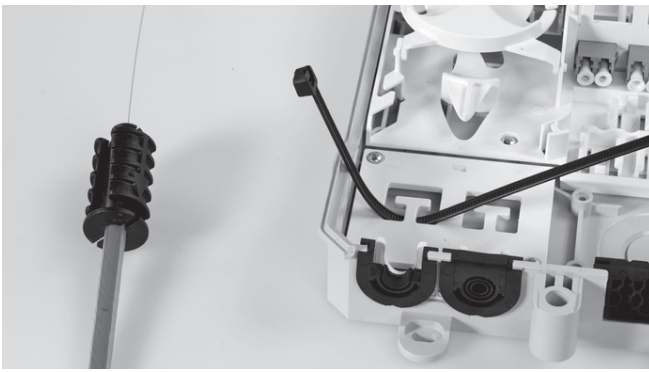

2.2.2 Install the tube with fiber into the cable entrance and secure with the tie-wrap.

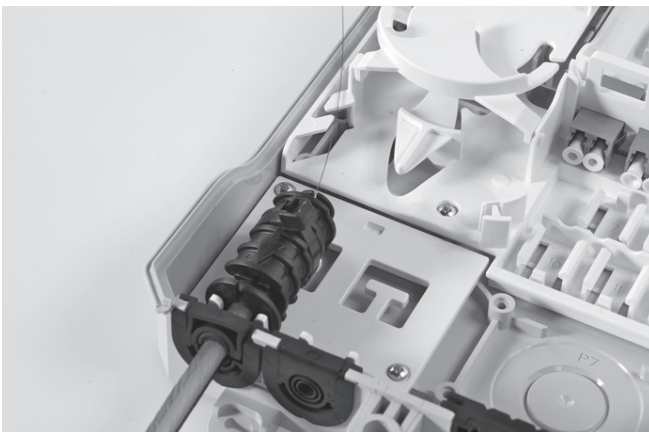

2.2.3 Close the wrap around rubber seal with the top part.

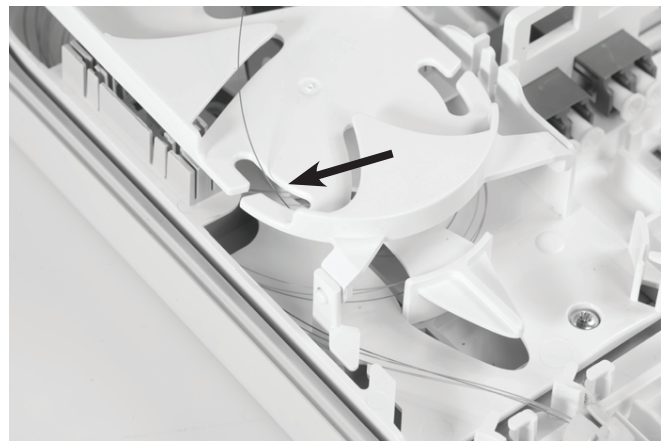
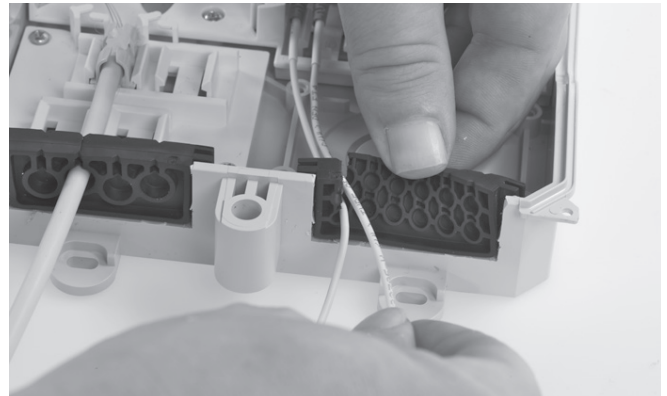
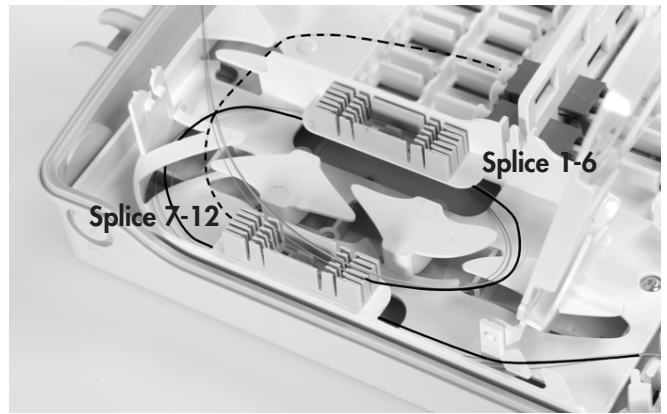

2.3.2 Fibers who will be spliced can be stored in this storage area, fibers who will be used later should be routed to the dark storage area trough the port shown on the picture. This to avoid crossing when dark fibers has to be spliced later.

2.3 Fiber routing



2.3.1 Route the fibers to the storage area. All fibers should enter through this port.



2.3.3 Connect the pigtails into the designated adaptors.



2.3.4 The pigtails should be stripped when entering the storage area in a straight line.



2.3.6 Close the storage area with the dark fiber storage tray.

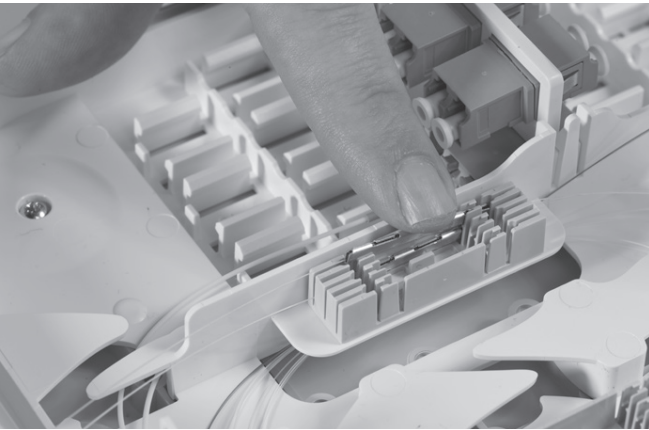

2.3.5 Splice the pigtails and store the splices in the splice holder, first use the left holder as shown on the picture, this to avoid crossings when adding a new incoming cable.

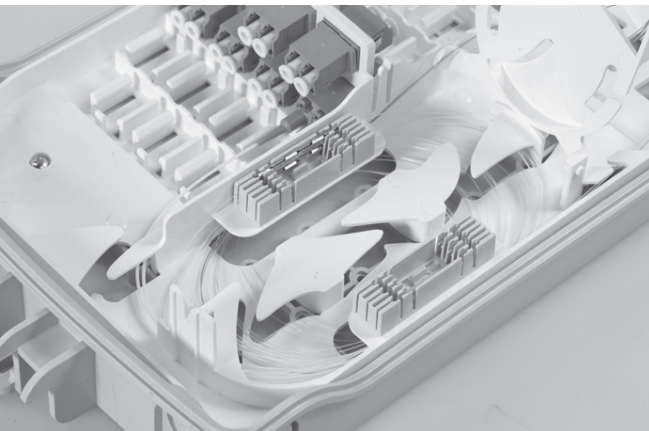

2.4 In case of splitters

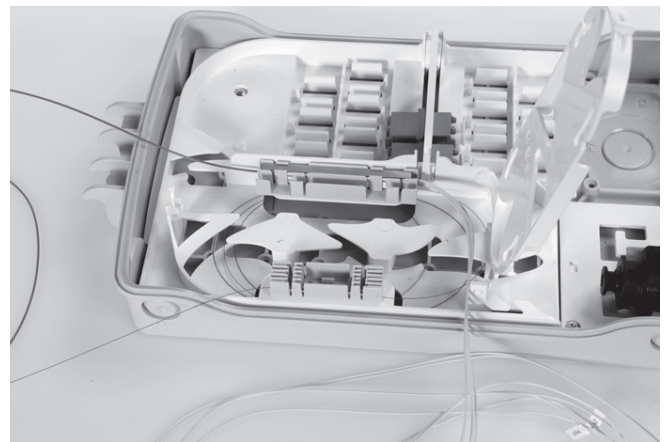
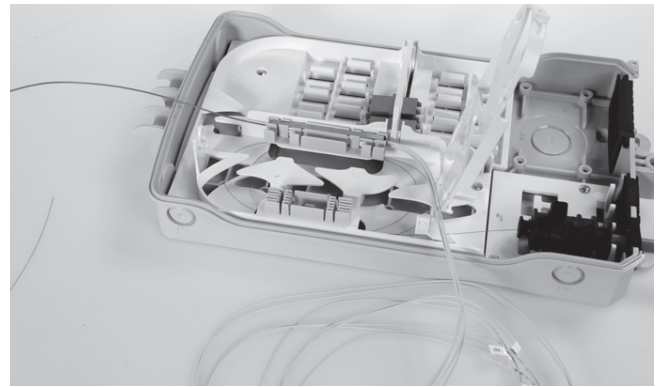

2.4.1 Install the splitter into the splitter holder, take care of the orientation. Splice the incoming fiber of the splitter to the fiber cable. Store the overlength into the storage area.

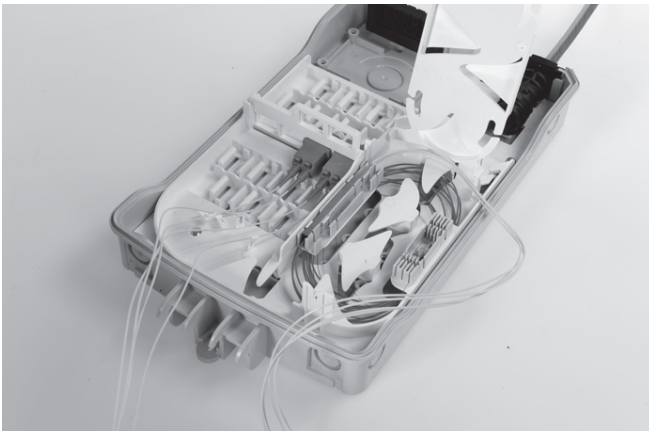

2.4.2 Install the outgoing pigtails of the splitter into the designated adaptors. Store the overlength into the storage area.



2.5 Patchcords



2.5.1 Install the patchcords into the designated adaptors.

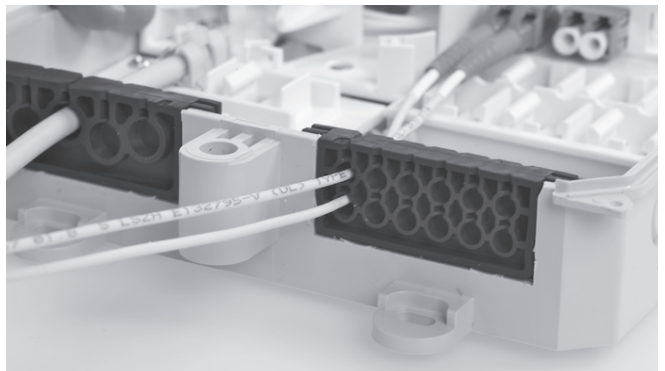
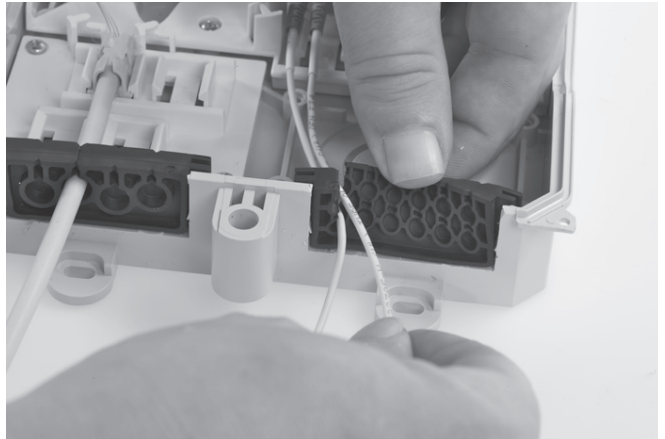

2.5.3 Install the patchcords into the designated adaptors and install them into the rubber seal one on top of the other as shown on the picture.

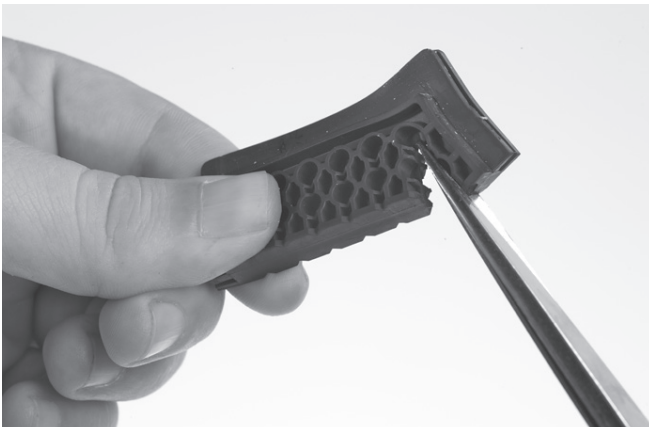

2.5.2 Cut open the ports needed for the patchcords.



2.5.4 Close the box.

To find out more about CommScope® products, visit us on the web at www.commscope.com

For technical assistance, customer service, or to report any missing/damaged parts, visit us at:
<http://www.commscope.com/SupportCenter>

© 2017 CommScope, Inc. All rights reserved.

All trademarks identified by ® or ™ are registered trademarks or trademarks, respectively, of CommScope, Inc.

This document is for planning purposes only and is not intended to modify or supplement any specifications or warranties relating to CommScope products or services.

This product is covered by one or more U.S. patents or their foreign equivalents. For patents, see:
www.commscope.com/ProductPatent/ProductPatent.aspx.