

Home Fiber Termination Point

Contents

1	Introduction	
2	Kit content	
3	Installation Instruction	
3.1	Install the base	
3.2	Cable preparation	
3.3	Cable termination	
3.4	Cable splicing	
3.5	Close the cover	

1 Introduction

The HFTP is a compact fiber termination point for use at the final fiber termination point in the customer premises. It provides mechanical protection and fiber management in an attractive format suitable for use inside customer premises.

2 Kit content

- Base with tray
- Cover (including screw for screw-on cover version)
- Screw label (for screw-on cover version only)
- Mark label (for screw-on cover version only)
- Foam (8cm)
- Tie-wrap (3pcs)
- Shuttered adaptors

3 Installation Instruction

3.1 Install the base

3.1.1 Open the cover (release the cover screw at first for screw-on version)

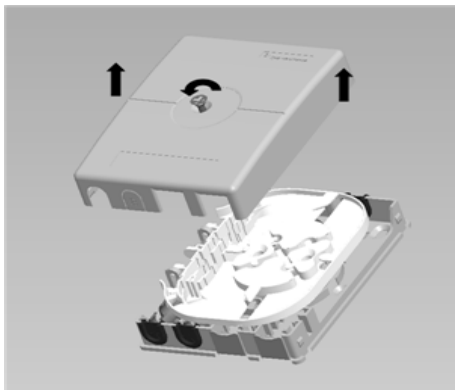

3.1.2 Use the fixation screws to install the base onto an insert box or directly on the wall by using the appropriate holes. If the cable comes from an insert box, the over-length can be stored in the insert box and pulled out through the cable entrance on bottom of the HFTP.

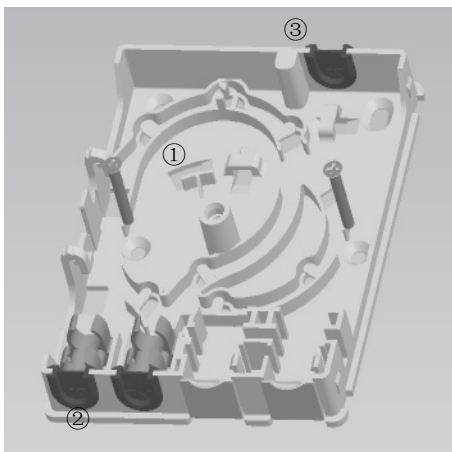

Note: The tray can be removed by pushing the hinge. This will make installation easier. The tray can be re-installed after completion of step 3.3.1.

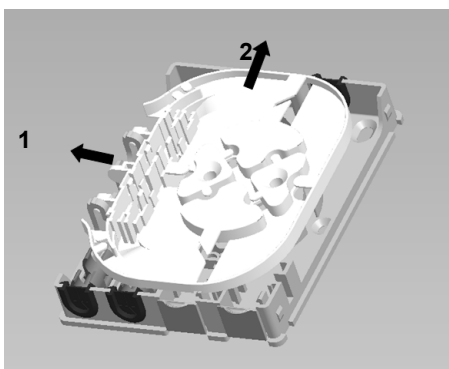

3.2 Cable preparation

Note: For field installable connector where no splicing is required, follow the connector installation instruction followed by section 3.2.3, 3.2.4 & 3.3.3 and 3.3.4.

3.2.1 There are 1 cable entry point on the rear wall of HFTP①, 2 on base② and 1 on top③ (See drawing in section 3.1.2). Select a suitable cable entry point and mark the cable at 20mm from the cable entry point, after ensuring the 1.2m of cable available for internal routing and connection.

Note: Cable diameter maximum is 6mm.

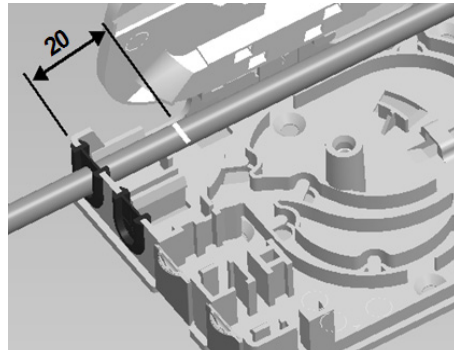

3.2.2 Ensure that 1.2m length of cable is stripped back to the marked point and remove the jacket from the marked point. Wrap the suffered foam on the jacket end.

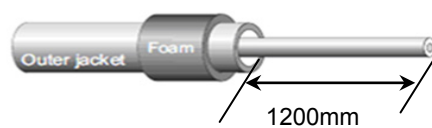

3.2.3 If cable entry is at the base of the HFTP, then take out the KTU from the HFTP. Fix the cable with foam to the KTU by using tie wrap. For cable with Kevlar, terminate the Kevlar by wrapping twice around the KTU before using the tie wrap.

If the cable enters the HFTP from the rear wall or top of the HFTP, then simply fix the cable with foam to the HFTP by tie wrapping.

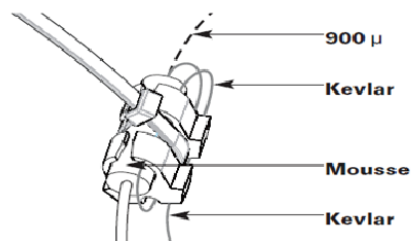

3.2.4 Cut the rubber gasket on the cable entry point by following the marked line on the gasket. Place the KTU with cable back in position until a “click” is felt.

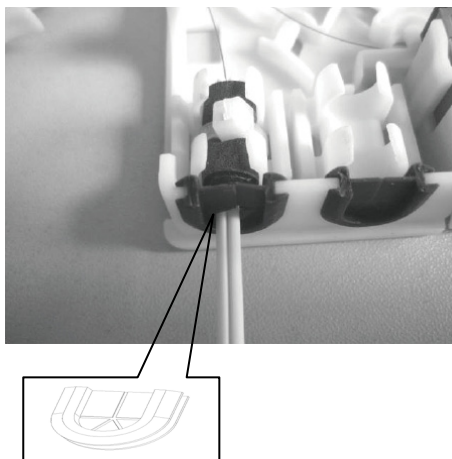

3.3.3 Install the adaptor(s). Position the adaptor so that the end with the spring is facing inwards. Remove the dust cap from the end of the adaptor which faces outwards from HFTP.

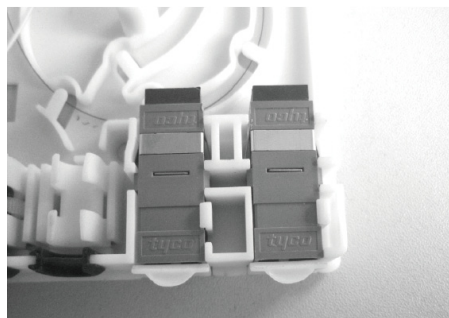

3.3.4 Remove the “internal” dust cap from the adaptor. Clean the connector of pigtail and plug in. Loop the pigtail to tray through the retainer as indicated.

3.3 Cable termination

3.3.1 Loop the cable on the base of the HFTP for one revolution. Refer to the following drawing for cable routing from different entrance position.

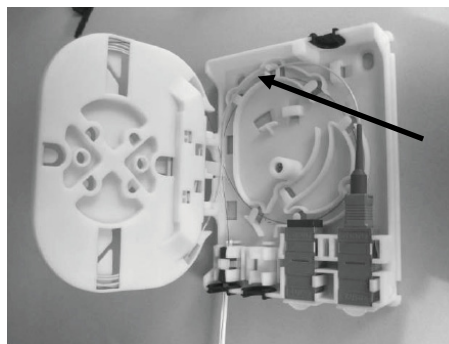
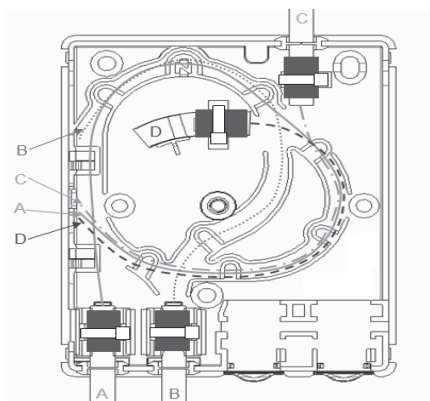

3.3.5 Splice the cable to a pigtail.

3.3.6 If RECORDSplice is used, store it directly in the holder. For fusion splice protector, SMOUV or mechanical ANT splicer, press the suffered adaptor into the holder first.

3.3.2 Lead the fiber to the tray.

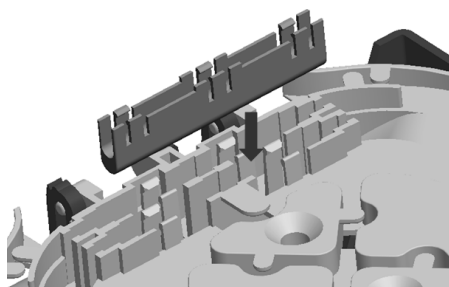
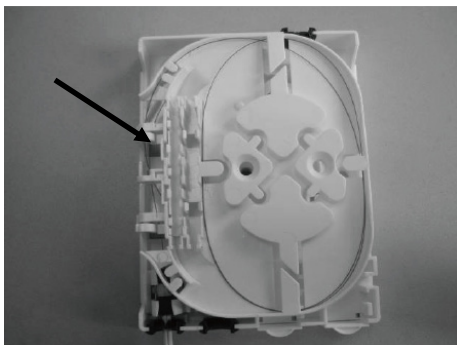

3.3.7 The fiber slack should be coiled on the tray..

3.4 Cable splicing

Note that 2 cables from different entrances can be spliced together by crossing on the tray if needed.

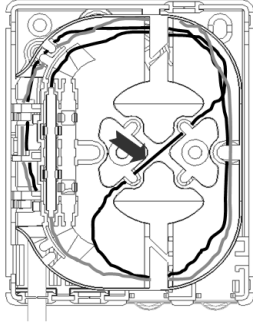

3.5.3 For the screw-on cover version, paste the screw label. Note on the mark label and paste it on the cover if needed.

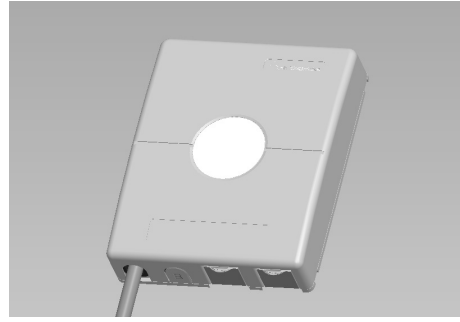

3.5 Close the cover

3.5.1 Put the cover onto the base. If the cable enters the HFTP from top, knock out the cable inlet port on cover.

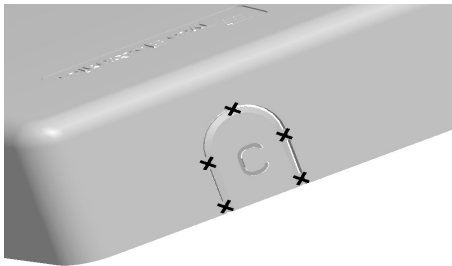

3.5.2 Place the cover by snatch. Fix it with screw for screw-on cover version. a "click" is felt.

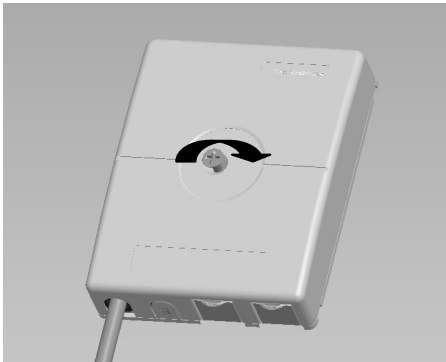

Tyco Electronics (Shanghai) Co.,Ltd.
No. 307 Qinjiang Road
CaoHeJing Hi-Tech Development Park
Tel: 86 21 61067000
86 4008206015
www.te.com/telecom

TE (logo) and TE Connectivity are trademarks.

While TE Connectivity and its affiliates referenced herein have made every reasonable effort to ensure the accuracy of the information contained in this catalog, TE Connectivity cannot assure that this information is error free. For this reason, TE Connectivity does not make any representation or offer any guarantee that such information is accurate, correct, reliable or current. TE Connectivity reserves the right to make any adjustments to the information at any time. TE Connectivity expressly disclaims any implied warranty regarding the information contained herein, including, but not limited to, the implied warranties of merchantability or fitness for a particular purpose. TE Connectivity' only obligations are those stated in TE Connectivity' Standard Terms and Conditions of Sale. TE Connectivity will in no case be liable for any incidental, indirect or consequential damages arising from or in connection with, including, but not limited to, the sale, resale, use or misuse of its products. Users should rely on their own judgment to evaluate the suitability of a product for a certain purpose and test each product for its intended application.